















ASSEMBLY INSTRUCTION

IMPORTANT NOTE:

- ※PLACE ALL PARTS ON A CLEAN AND SMOOTH SURFACE SUCH AS A RUG OR CARPET TO AVOID THE PARTS FROM BEING SCRATCHED.
- ※KINDLY FOLLOW THE ASSEMBLY INSTRUCTIONS STEP BY STEP.
- ※DO NOT TIGHTEN ALL SCREWS UNTIL THE BED IS FULLY SET-UP.

PARTS LIST & HARDWARE LIST					
1:HEAD BOARD 1pc 	2:FOOT BOARD 1PC 	3: SIDE RAIL 2PCS 	4:SLAT 12PC 	5: SINGLE PLASTIC CAP 24PCS 	6 : LEG 4PCS 
7:SLAT 1PC 					
A:BOLT 4PCS  M8X75mm	B:BOLT 8PCS  M8X30mm	C:SPRING WASHER 12PCS 	D:FLAT WASHER 12PCS 	E:ALLEN KEY 1PC  M8	F:Screw 2PCS  M4x30
G:ALLEN KEY 1PC 					

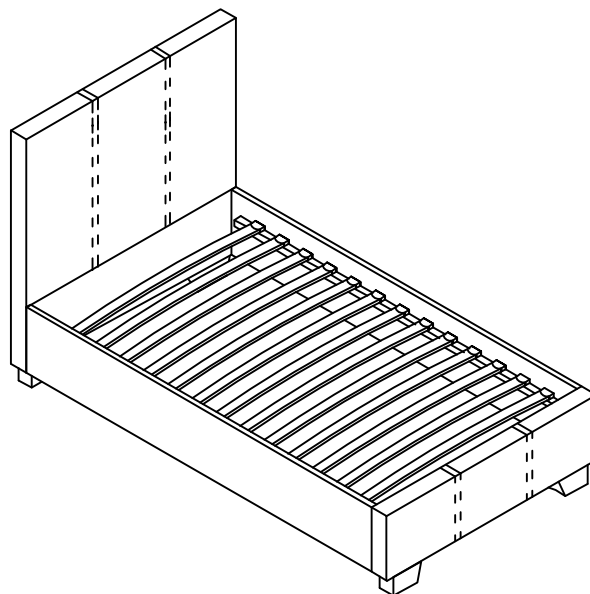

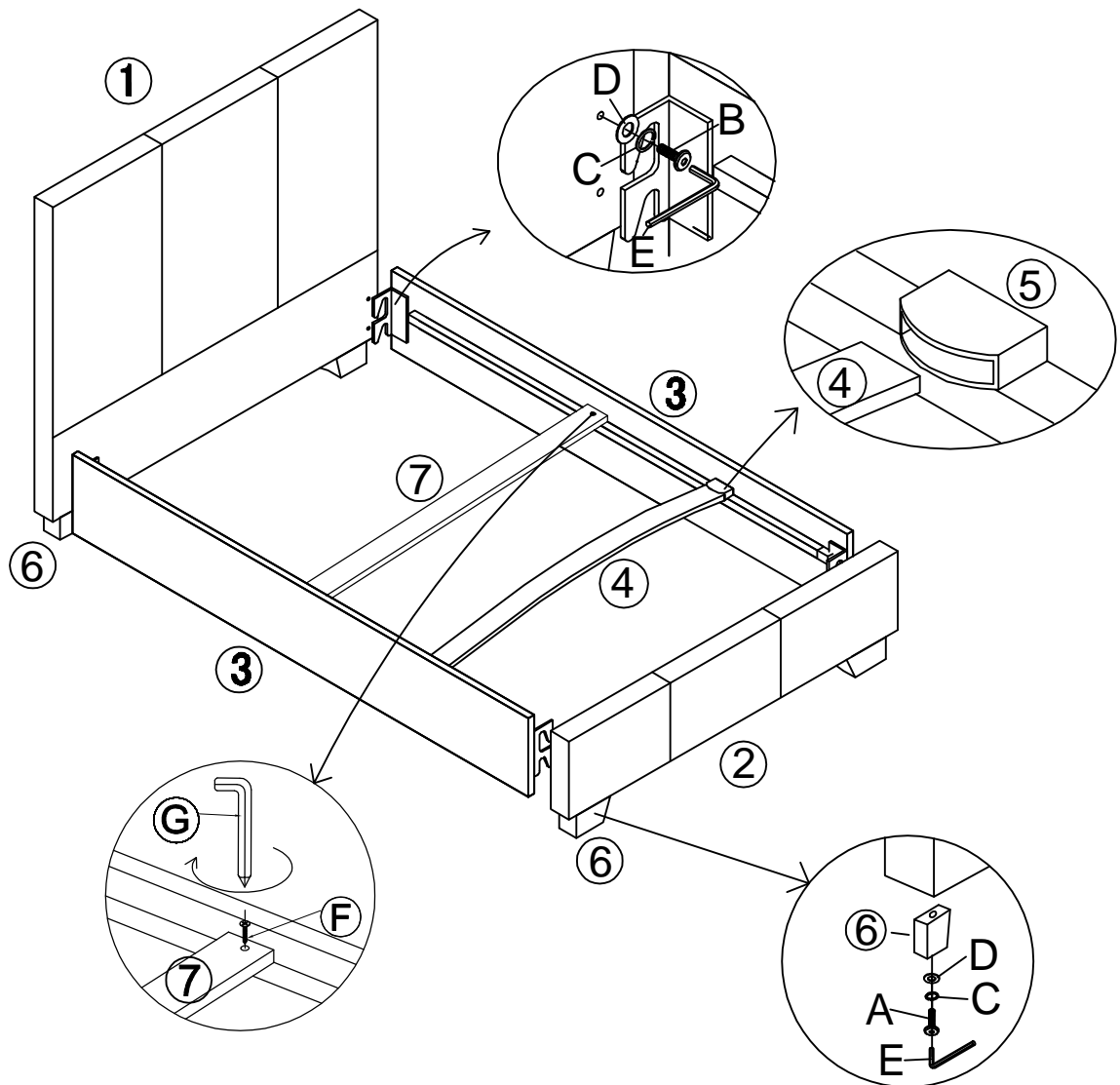

- STEP 1 :FIXING LEGS TO HEADBOARD AND FOOTBOARD;
 STEP 2 :FIXING SUPPORT LEGS TO CENTR SUPPORT BAR;
 STEP 3 :FIXING SIDE RAILS AND CENTRE SUPPORT BAR TO HEADBOARD AND FOOTBOARD;
 STEP 4 :ONCE SLAT ASSEMBLED POSITION PEGS ON THE BASE OF CAPS INTO CORRESPONDING HOLES ON THE SIDE RAILS AND CENTRAL SUPPORT BAR,THEN CAREFULLY PRESS DOMN ON CAPS TO SECURE.