

ASSEMBLY DIAGRAM

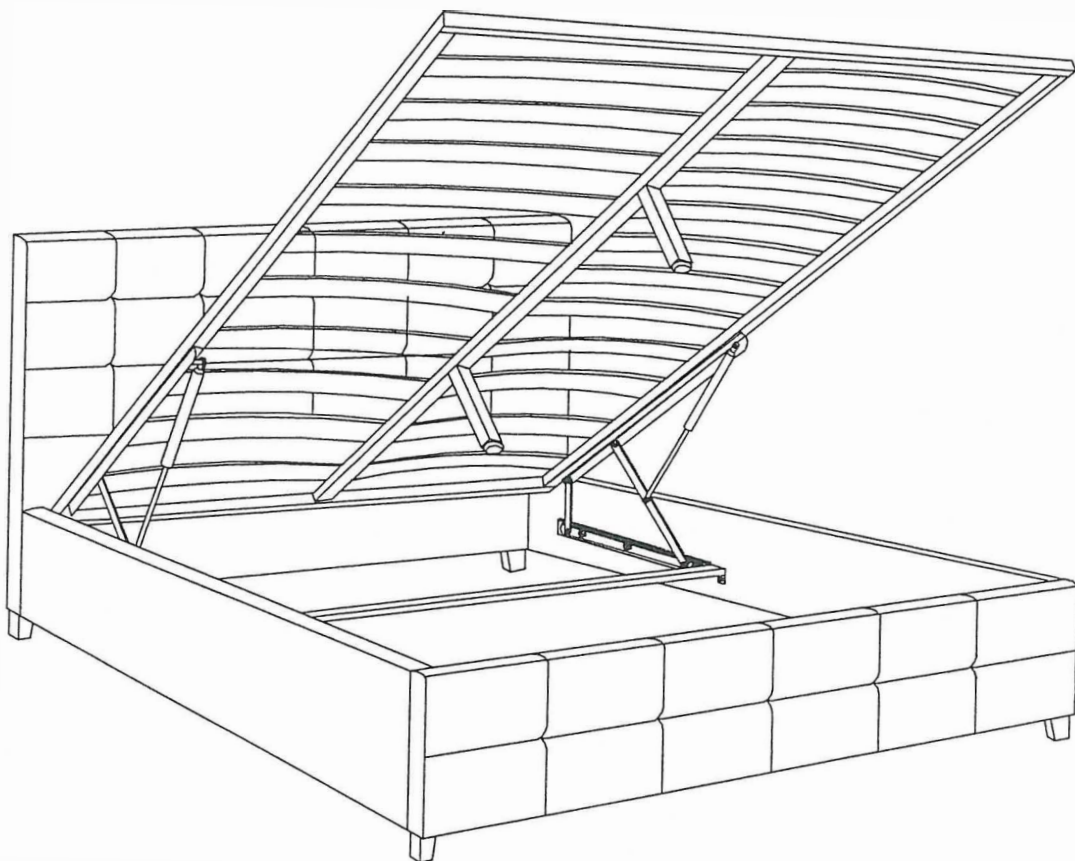





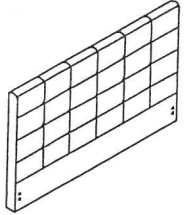
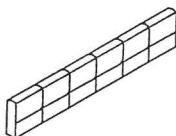
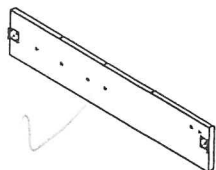
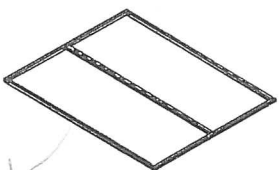

IMPORTANT NOTE:

- * PLACE ALL PARTS ON A CLEAN AND SMOOTH SURFACE SUCH AS A RUG OR CARPET TO AVOID THE PARTS FROM BEING SCRATCHED.
- * KINDLY FOLLOW THE ASSEMBLY INSTRUCTIONS STEP BY STEP.
- * DO NOT TIGHTEN ALL SCREWS UNTIL THE BED IS FULLY SET-UP.



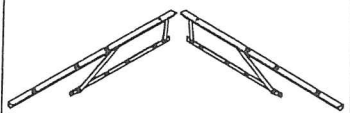

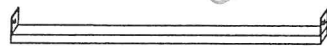

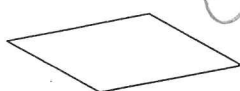
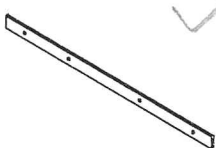



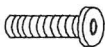







0006-00003

Parts List

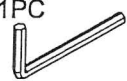
A: HEAD BOARD 1PC 	B: FOOT BOARD 1PC 	C: SIDE RAIL 2PCS 	D: BEDSTEAD KD 1SETS 
E: SLAT 26PCS 	F: ANGLE IRON 2PCS 	G: STEAM MOVING BAR 2PCS 	H: STEAM MOVING MECHANICA 2PCS 
I: SQUARE TUBE 1PC 	J: LEG 2PCS 	K : 1PC 	L : LEG 4PCS 
M : Non-Moven Bed Base 1PC 	N : 2PCS 		

Hardware List

1: BOLT 20PCS  M8X45mm	2: BOLT 8PCS  M8X30mm	3: BOLT 10PCS  M6X40mm	4: BOLT 10PCS  M6X20mm	5: ALLEN KEY 1PC  M8	6: NUT 14PCS 
7: FLAT WASHER 28PCS  M8	8: SPRING WASHER 28PCS  M8	9: ALLEN KEY 1PC  M8	10: SPANNER 1PC 	11: SLAT CAP 26PCS 	12: DOUBLE PLASTIC CAP 13PCS 
13: ANGLE IRON 2PCS 	14: ALLEN KEY 1PC  M6	15: FLAT WASHER 20PCS  M6	16: SPRING WASHER 20PCS  M6	17 1PC 	

STEP 1

1  4PCS

2  8PCS

7  12PCS

8  12PCS

9  1PC

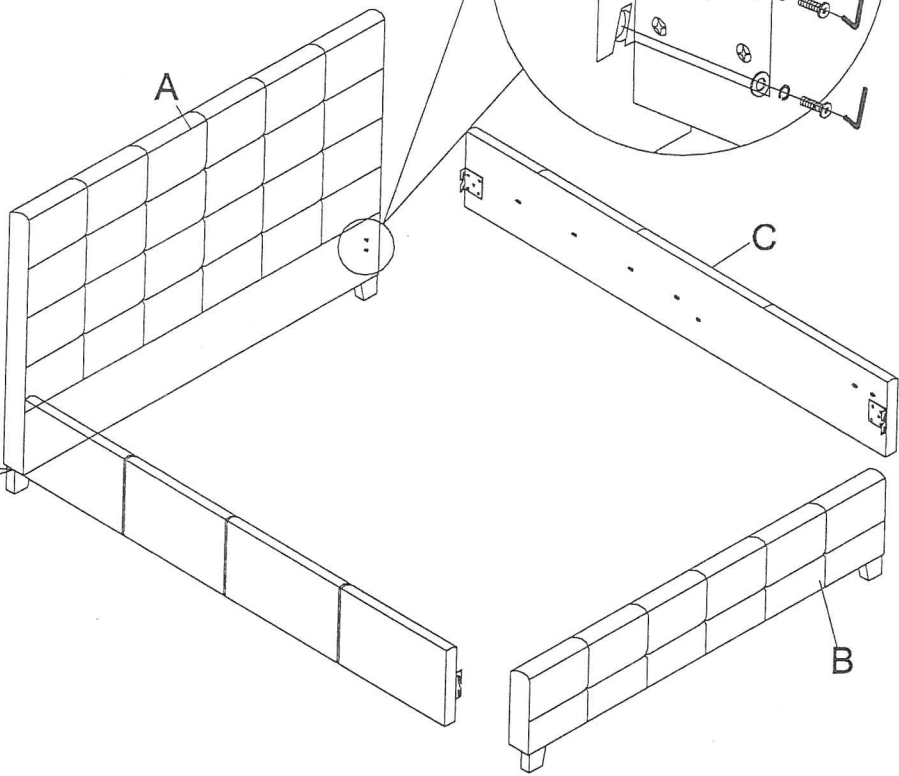
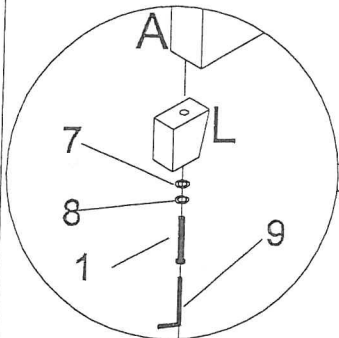

STEP 2

3  10PCS

4  10PCS

15  20PCS

16  20PCS

F  2PCS

14  1PC

I  1PC

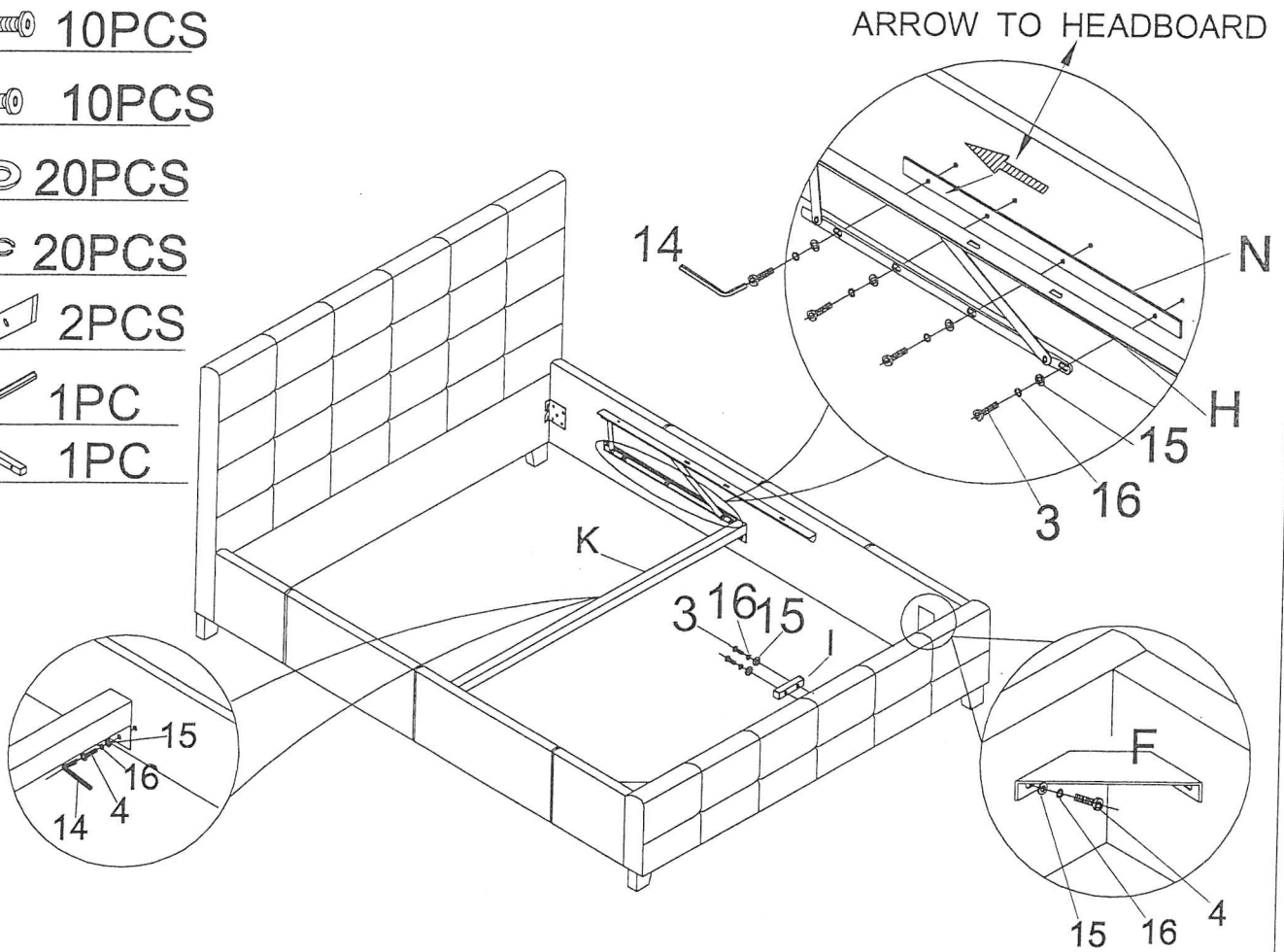

STEP 3

1  10PCS

7  10PCS

8  10PCS

6  10PCS

9  1PC

10  1PC

13  2PCS

17  1PCS

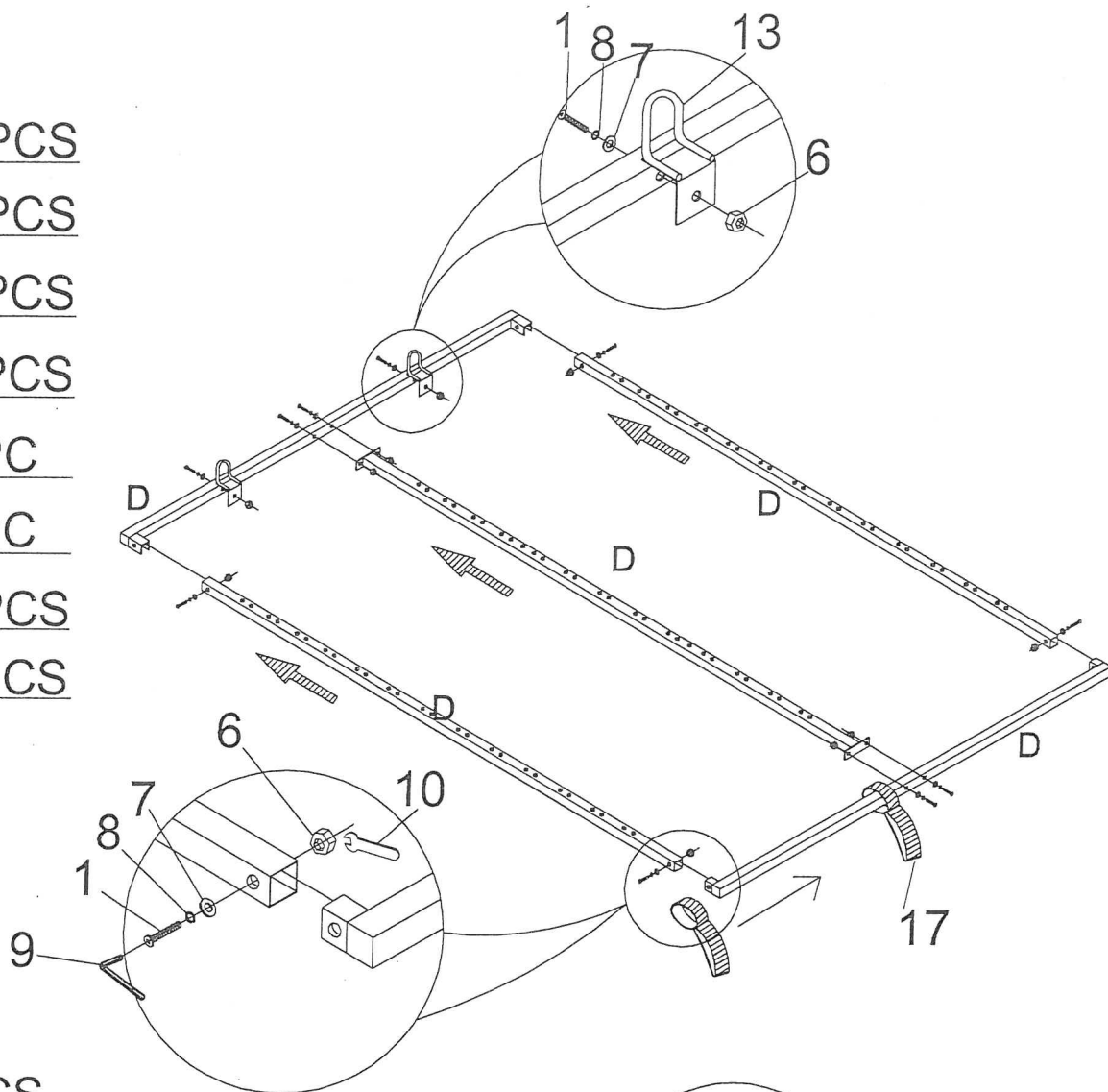

STEP 4

1  6PCS

7  6PCS

8  6PCS

6  4PCS

9  1PC

10  1PC

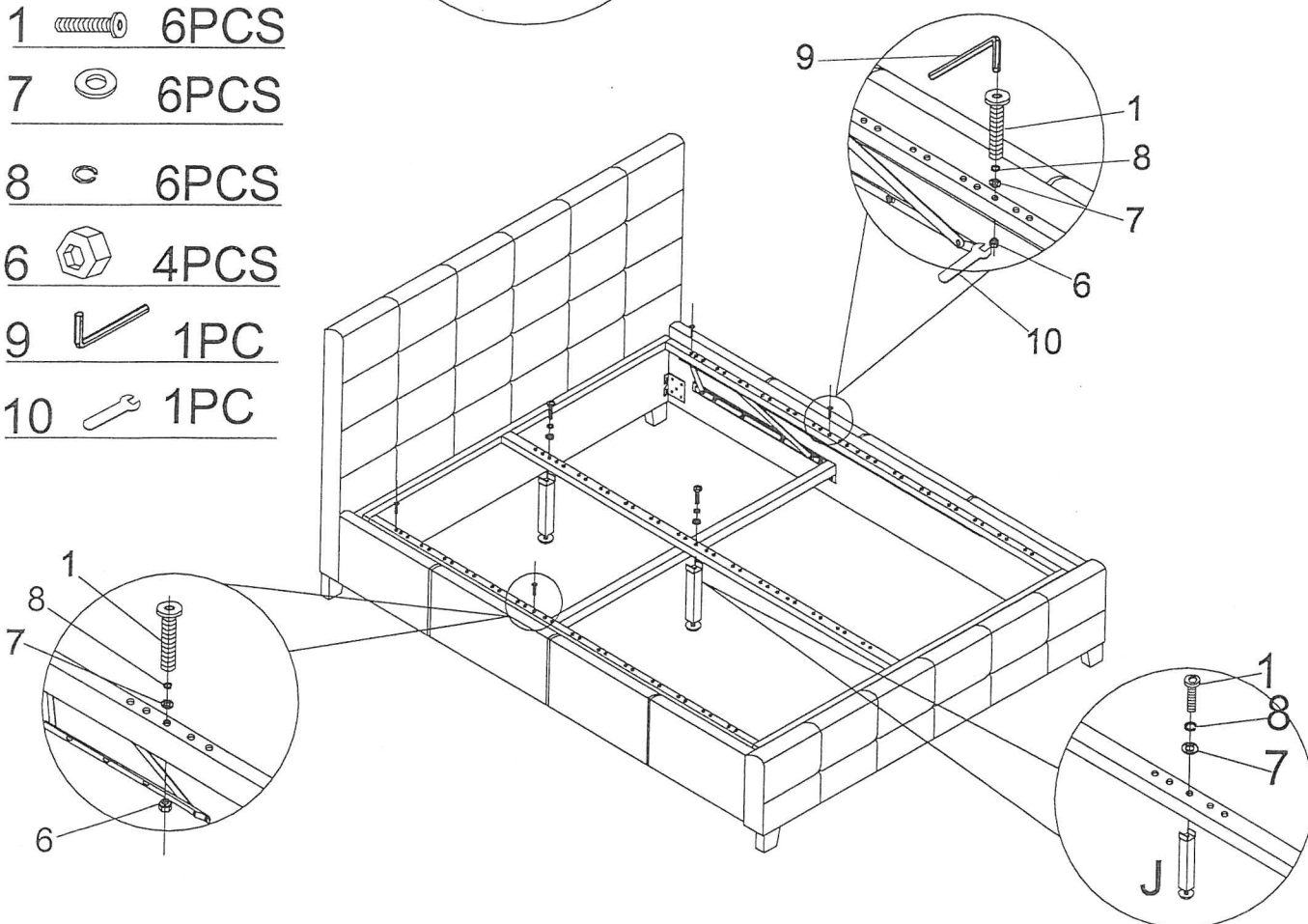

STEP 5

11  26PCS

12  13PCS

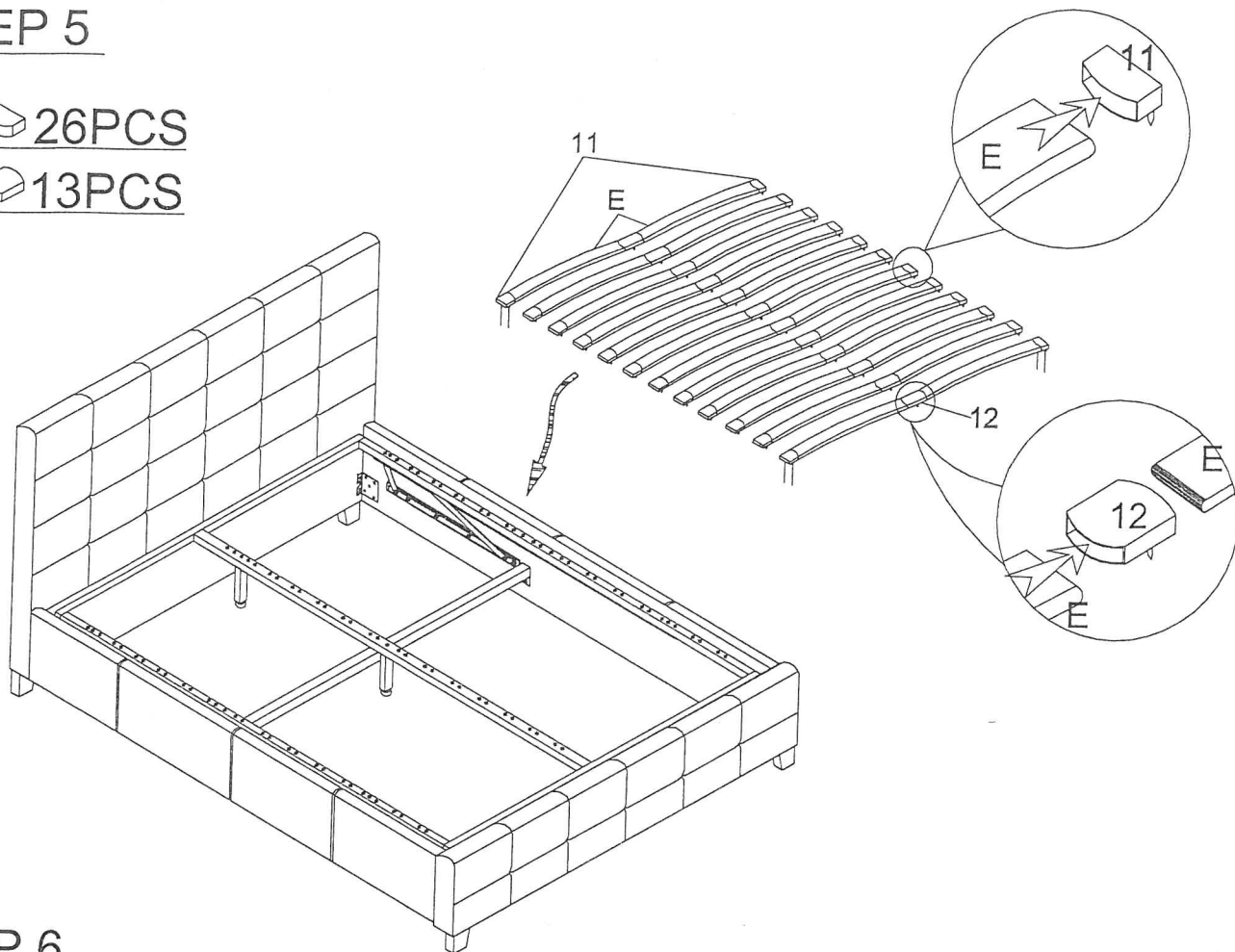

STEP 6

5  1PC

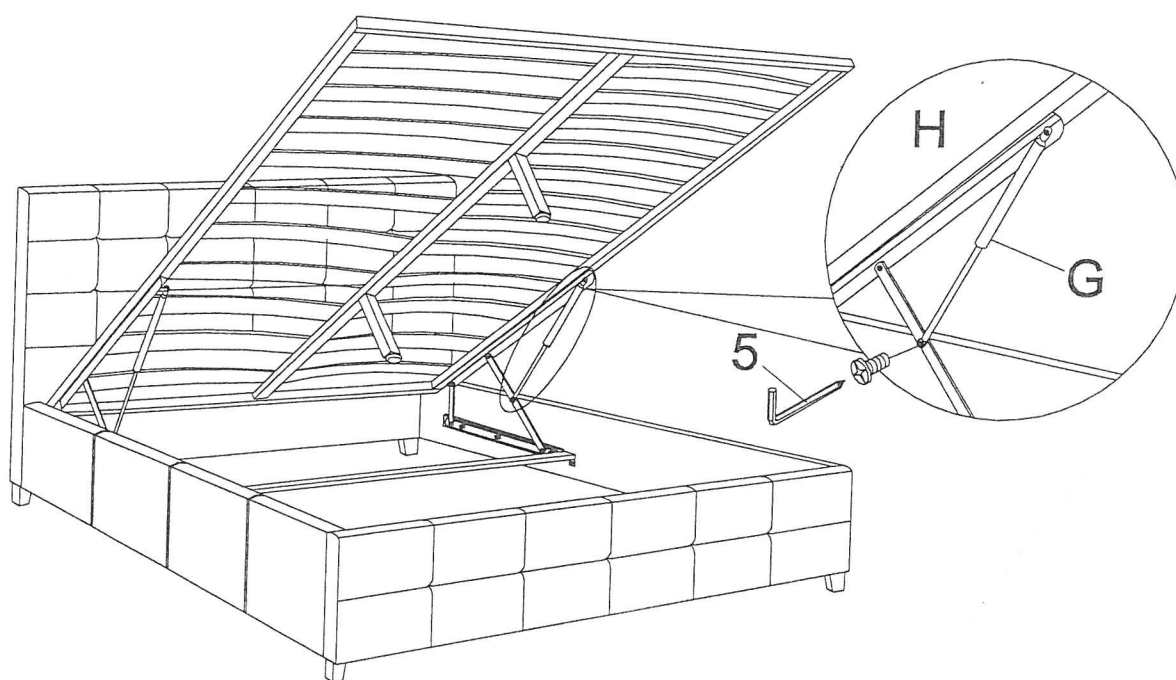

STEP 7

M  1PC

