













BLOSSOM

A	2x 328x300	1/4
B	328x300	1/4
C	626x300	1/4
D	1300x320	1/4
E	1300x320	1/4
F	2x 177x650	2/4
G	322x670	1/4
H	1738x250	2/4
I	1738x250	2/4
J	2x 500x270	3/4
K	468x250	3/4
L	2x 468x250	3/4
M	1410x80	2/4
N	2x 1450x247	2/4
O	315x495	3/4
P	322x497	3/4
Q	1700x250	2/4
R	2x 1368x250	4/4
S	400x250	4/4
T	2x 368x250	4/4

46x  10174	46x  Φ 8/30 10013	46x  50317	4x  40163	8x  50332	14x  50738	4x  51066	4x  10060
4x  50561	4x  10037	4x  Φ 6/80 10021	41x  Φ 3.5/16 10001	 10033			



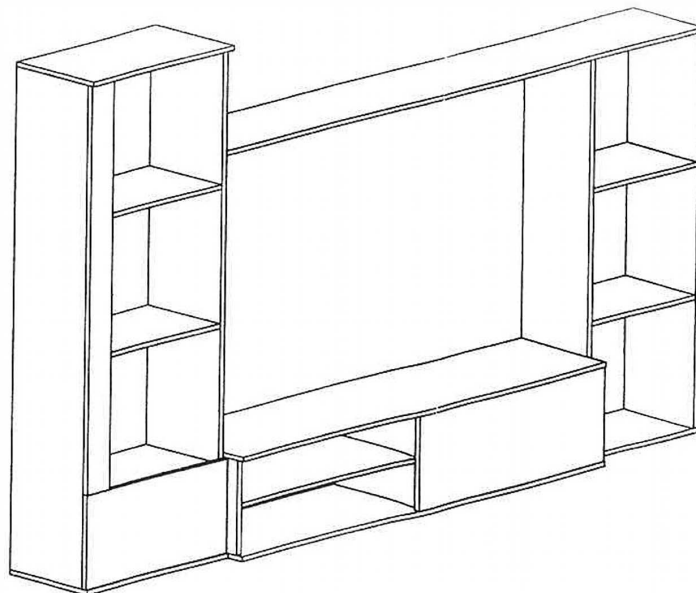
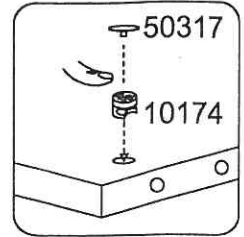
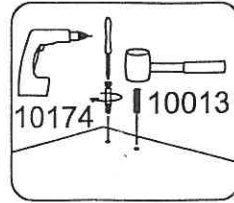
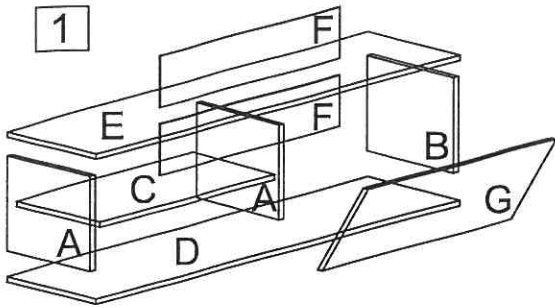

1.1

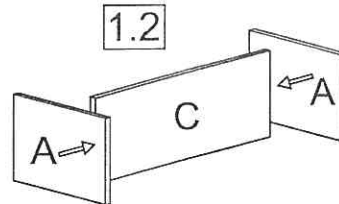
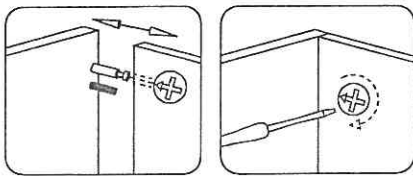
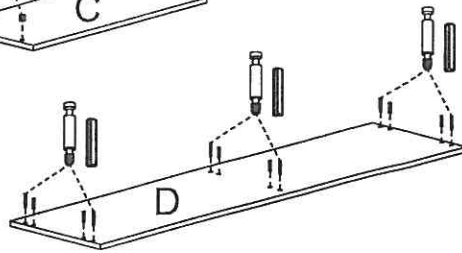
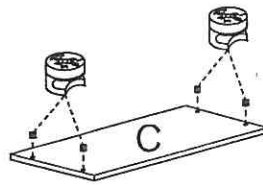
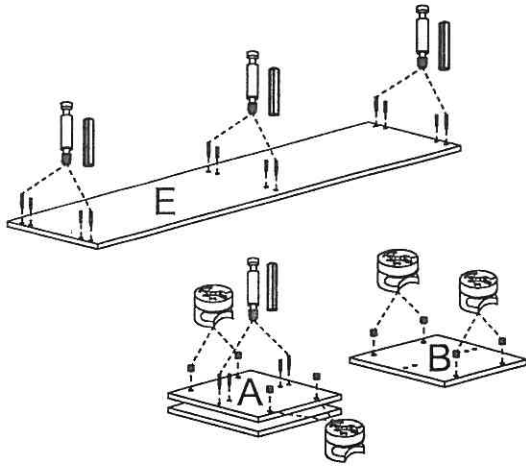

1.3

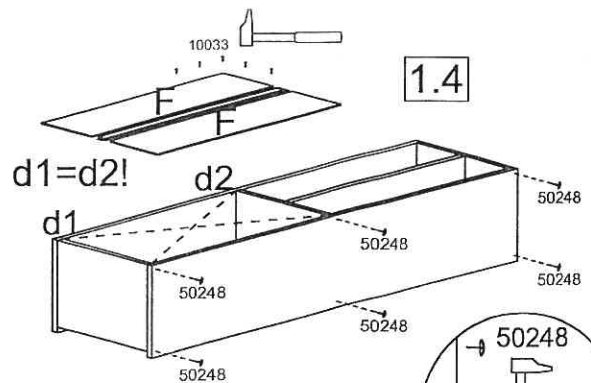
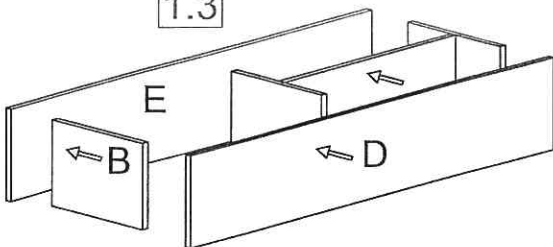

1.4

1.5

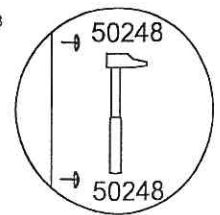
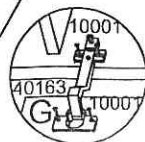
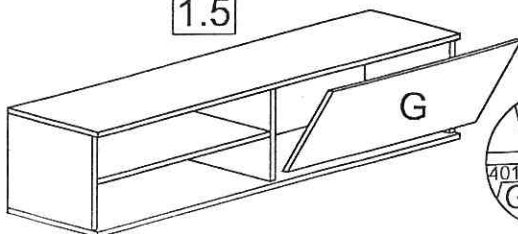

City 6022

A	2x 328x300	1/4
B	328x300	1/4
C	626x300	1/4
D	1300x320	1/4
E	1300x320	1/4
F	2x 177x650	2/4
G	322x670	1/4
H	1738x250	2/4
I	1738x250	2/4
J	2x 500x270	3/4
K	468x250	3/4
L	2x 468x250	3/4
M	1410x80	2/4
N	2x 1450x247	2/4
O	315x495	3/4
P	322x497	3/4
Q	1700x250	2/4
R	2x 1368x250	4/4
S	400x250	4/4
T	2x 368x250	4/4

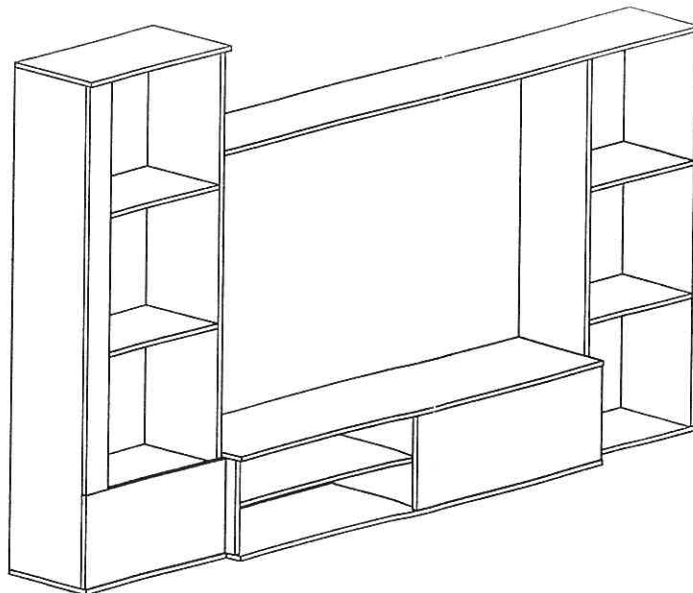
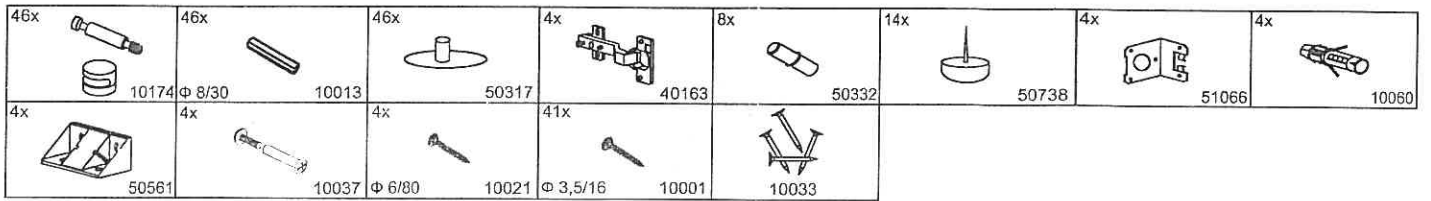

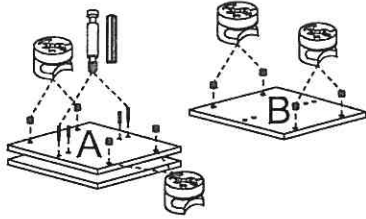
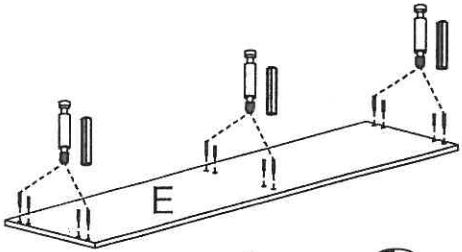
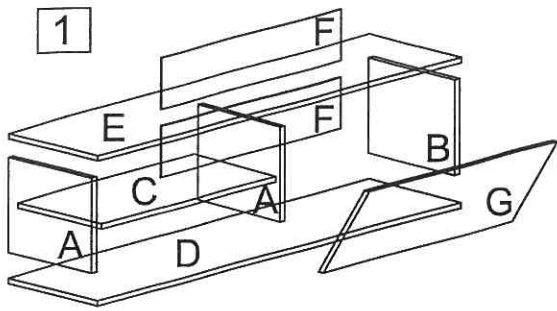

1.1

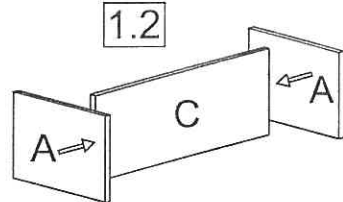
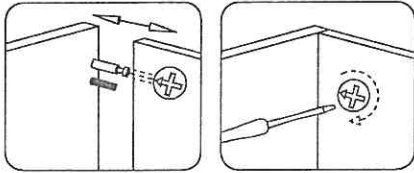
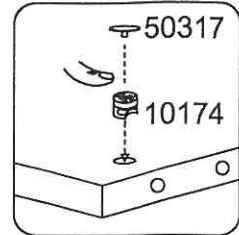
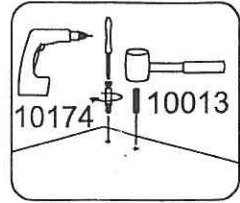

1.2

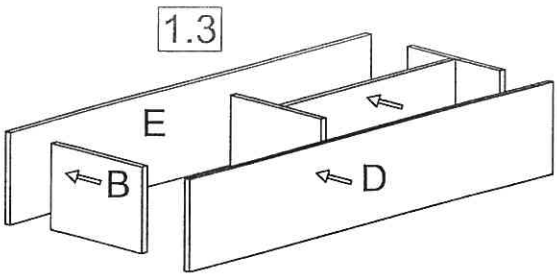

1.3

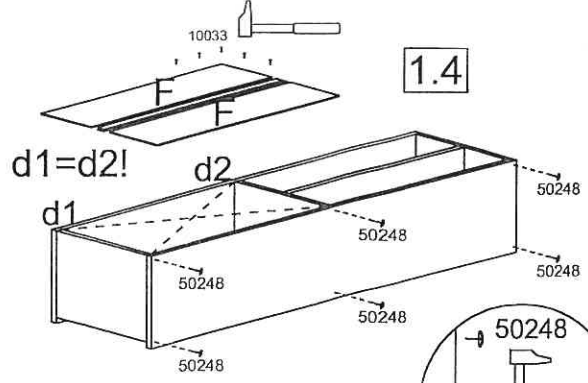

1.4

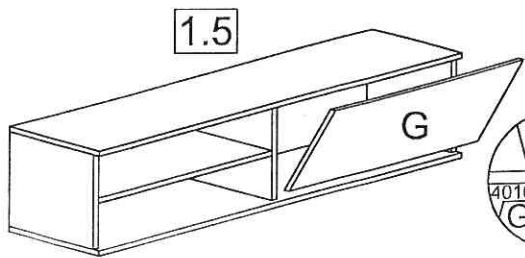

1.5

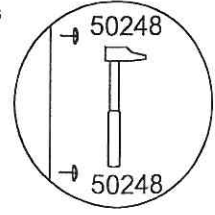
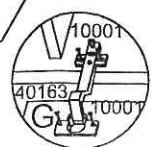

2

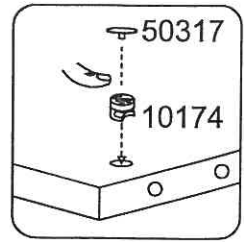
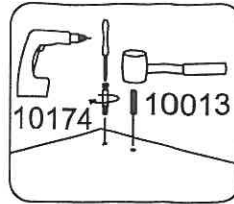
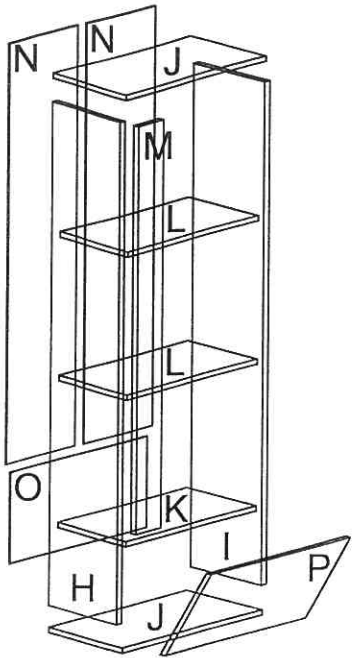

2.1

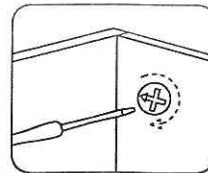
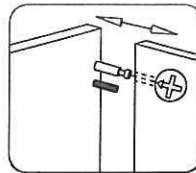
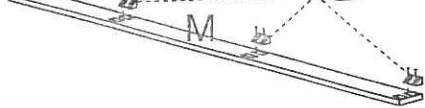
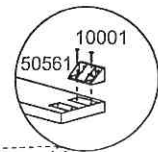
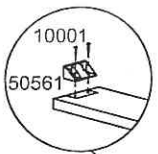
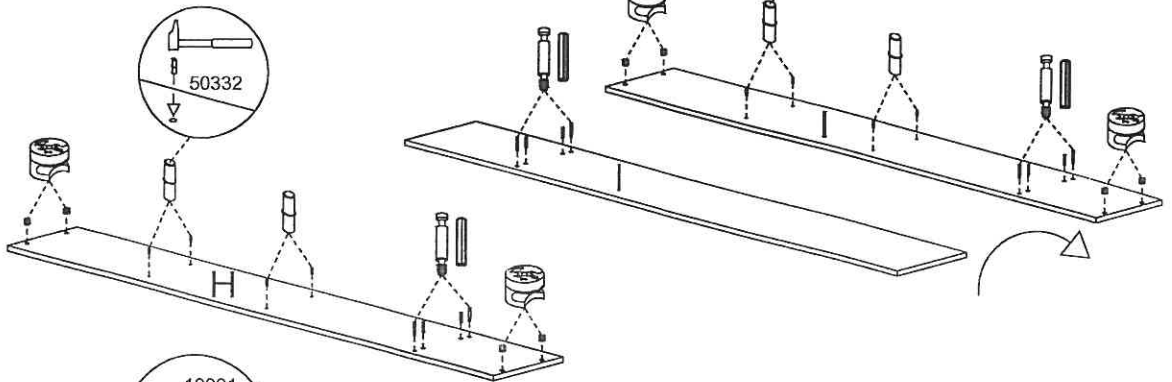
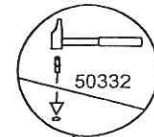
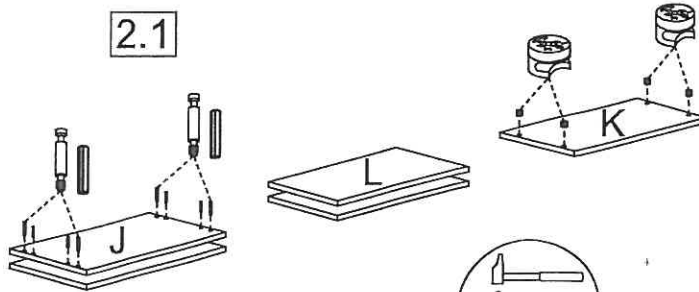

2.2

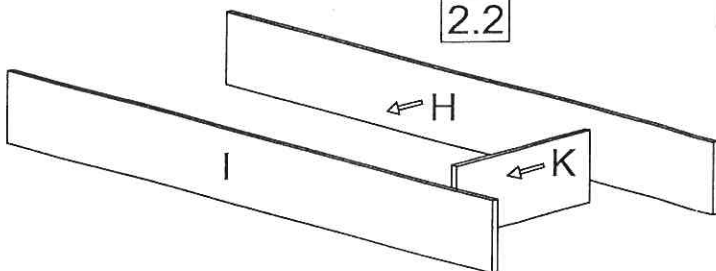

2.3

