



Dear Customer,

We design and produce our product for people to love and have fun with them as we do.

The product you bought was subjected to all sorts of tests and control before sending out to you.

Before start assembling, please check the whole components and accessories according to the lists. If you bought more than one product, to prevent confusion be sure that you completed the first product. Then start the other product's assembling.

Before start assembling, please clean all the components with a damp cloth. Also for usual cleaning, this will be enough.

Although all the products are produced and packed carefully, sometimes happen that some component is damaged during the transportation. In such a case please check the missing or damaged part and do not hesitate to contact us.

Do not use furniture forout of purposes. If you would like to use it, please contact us for further questions.

Do not directly contact your furniture with excessive heat, cold and humidity because the product can be affected.

WARNING





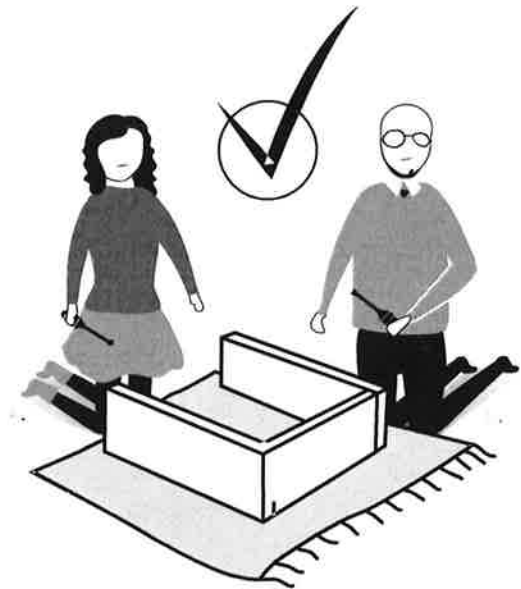



Serious or fatal crushing injuries can occur from furniture tip-over. To prevent this furniture from tipping over it must be permanently fixed to the wall with the included wall attachment devices.

Fixing devices for the wall are not included since different wall materials require different types of fixing devices. Use fixing devices suitable for the walls in your home. For advice on suitable fixing systems, contact your local specialized dealer.



ASSEMBLY INSTRUCTION

123-000210

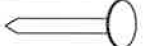
HARDWARE LIST			
NO	DESCRIPTION		QTY
I	JCBCW SCREW M6.3 x 50		15pcs
II	JCBCW SCREW M6.3 x 65		20pcs
III	M4 ALLEN KEY		1pc
IV	M8 x 30 PLASTIC DOWEL		34pcs
V	PVC NAIL WITH PIN		22pcs
VI	M3.5 x 30 CHIPBOARD SCREW		20pcs
VII	M4 x 25 CHIPBOARD SCREW		20pcs
VIII	STICKER		16pcs
IX	Q-FIT		12sets
X	NAIL		20pcs

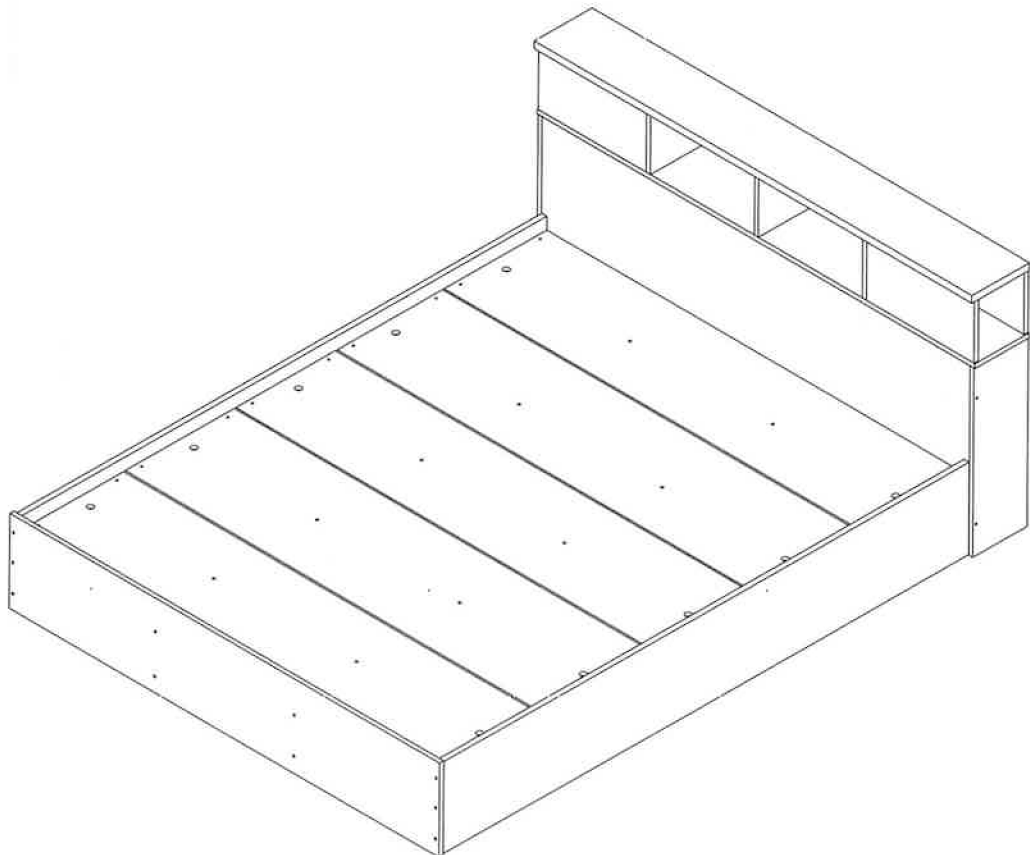

STEP 1

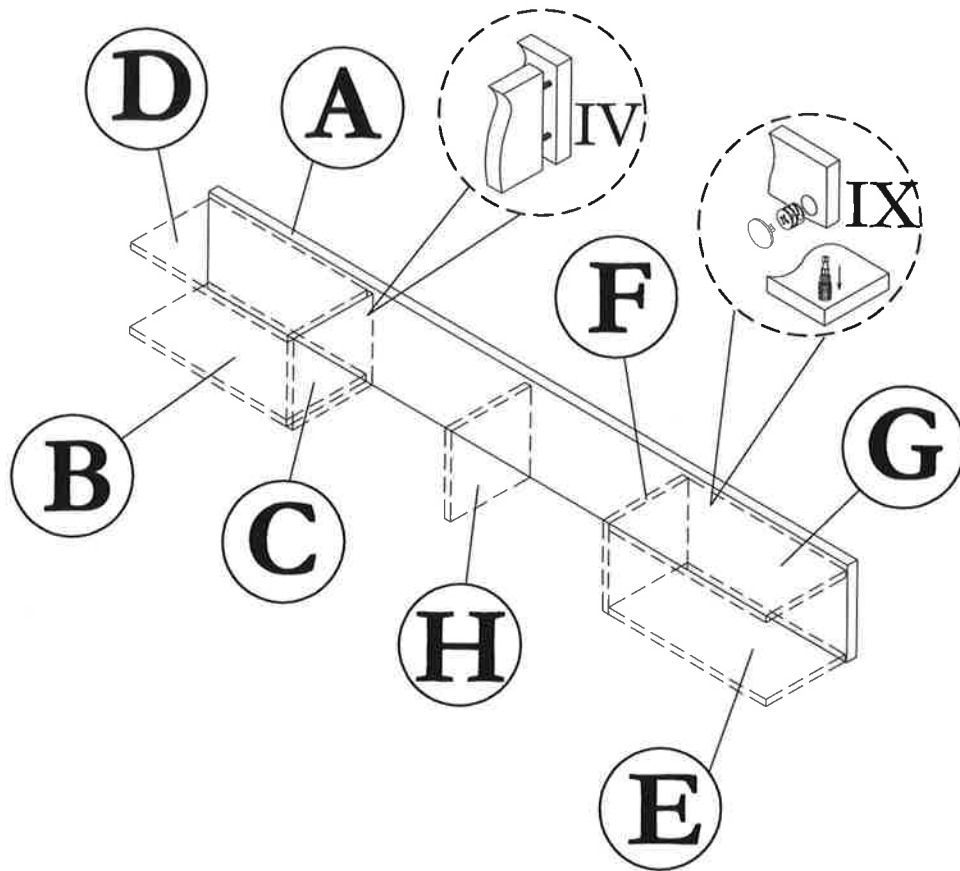

STEP 2

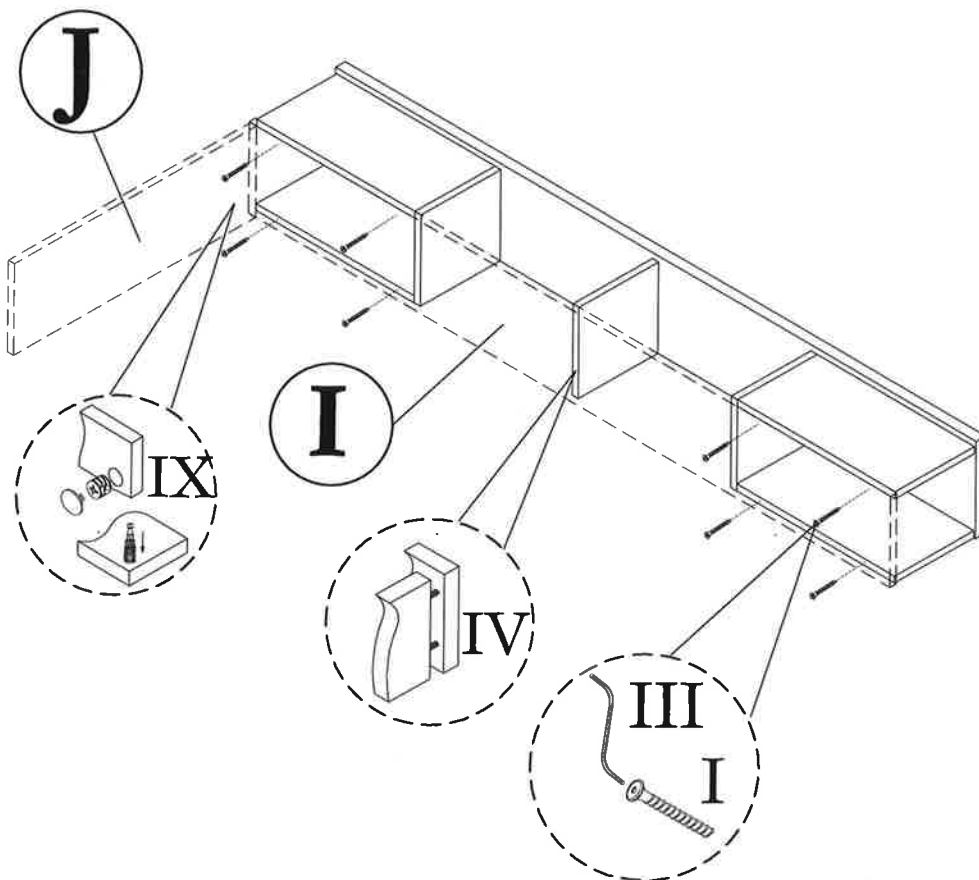

STEP 3

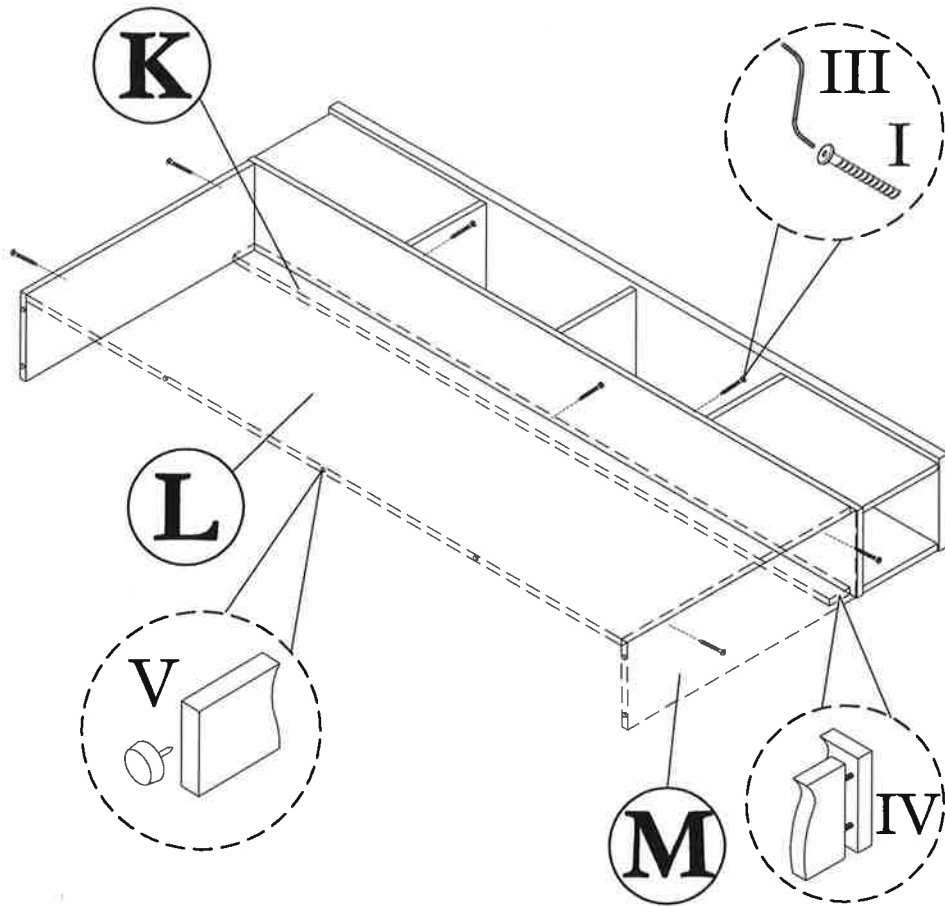

STEP 4

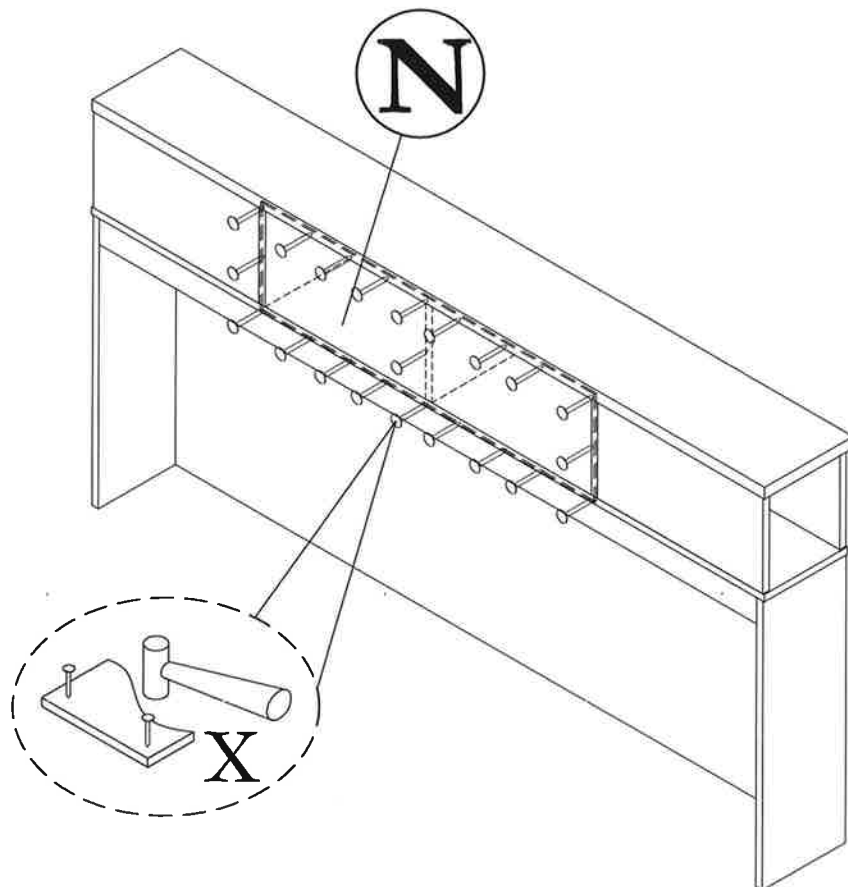

STEP 5

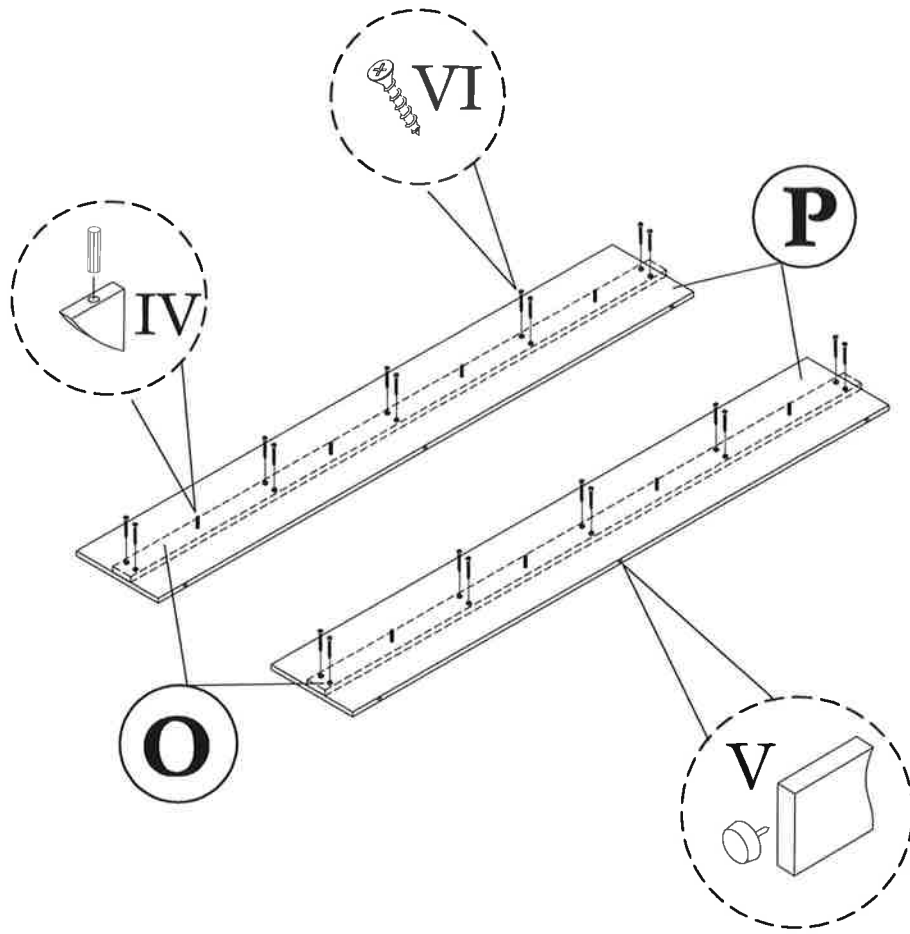

STEP 6

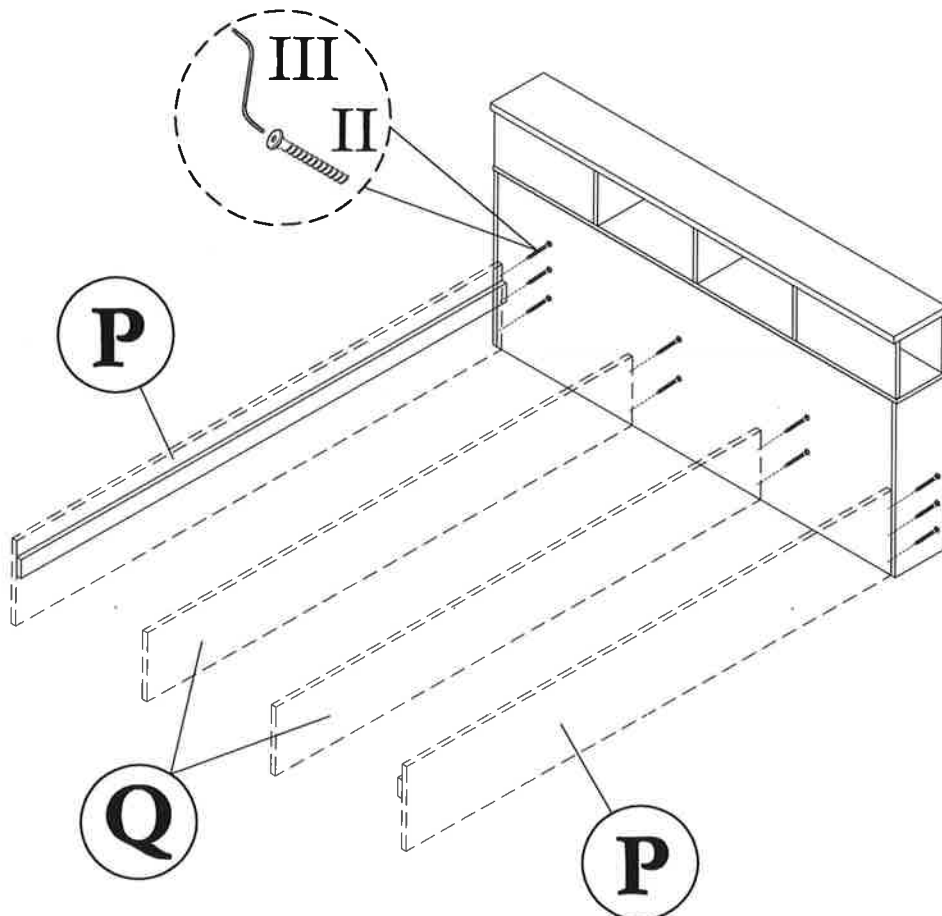

STEP 7

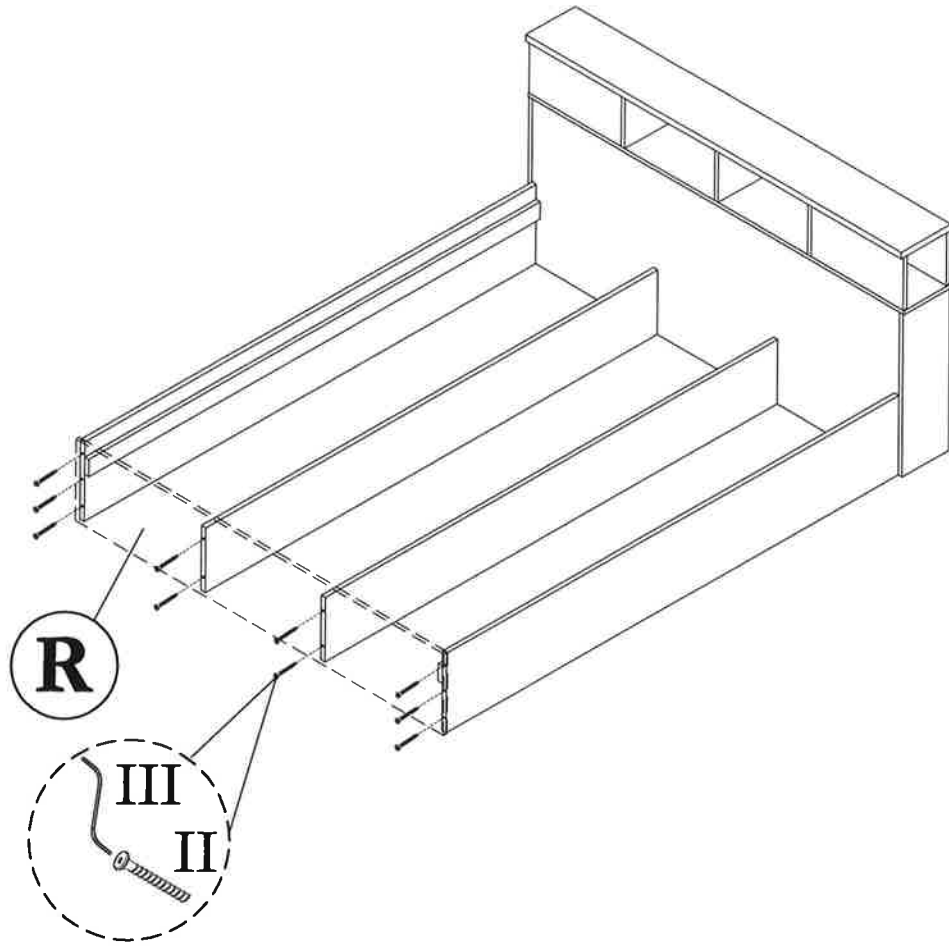

STEP 8

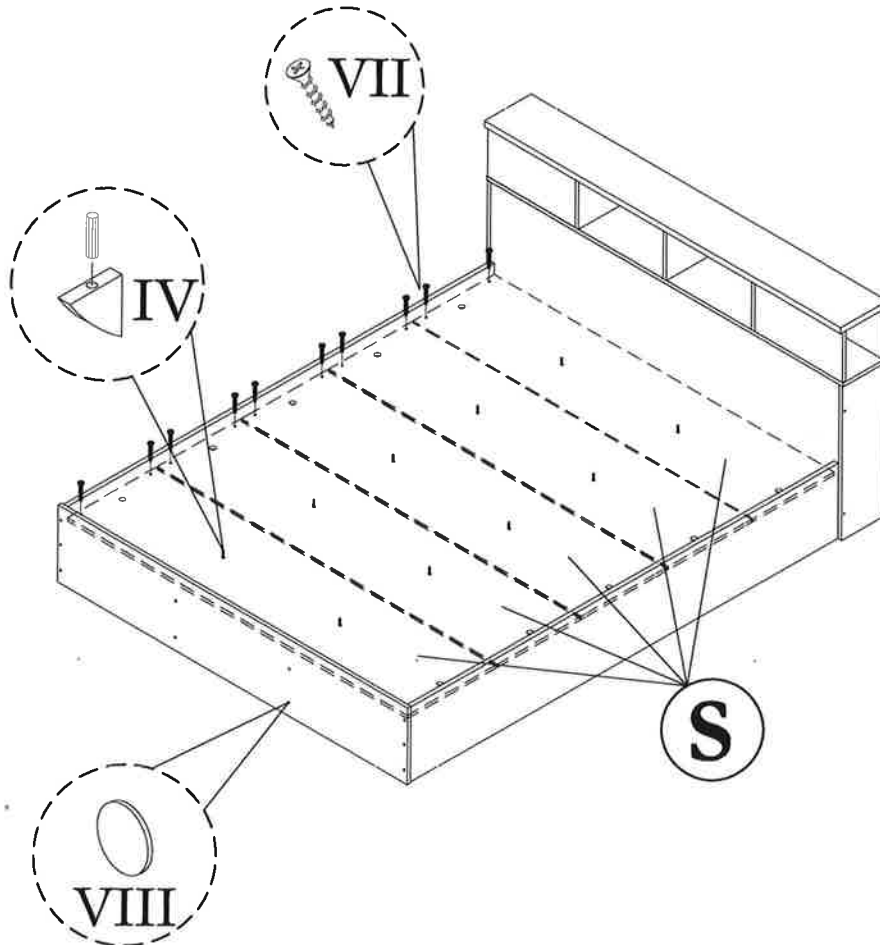

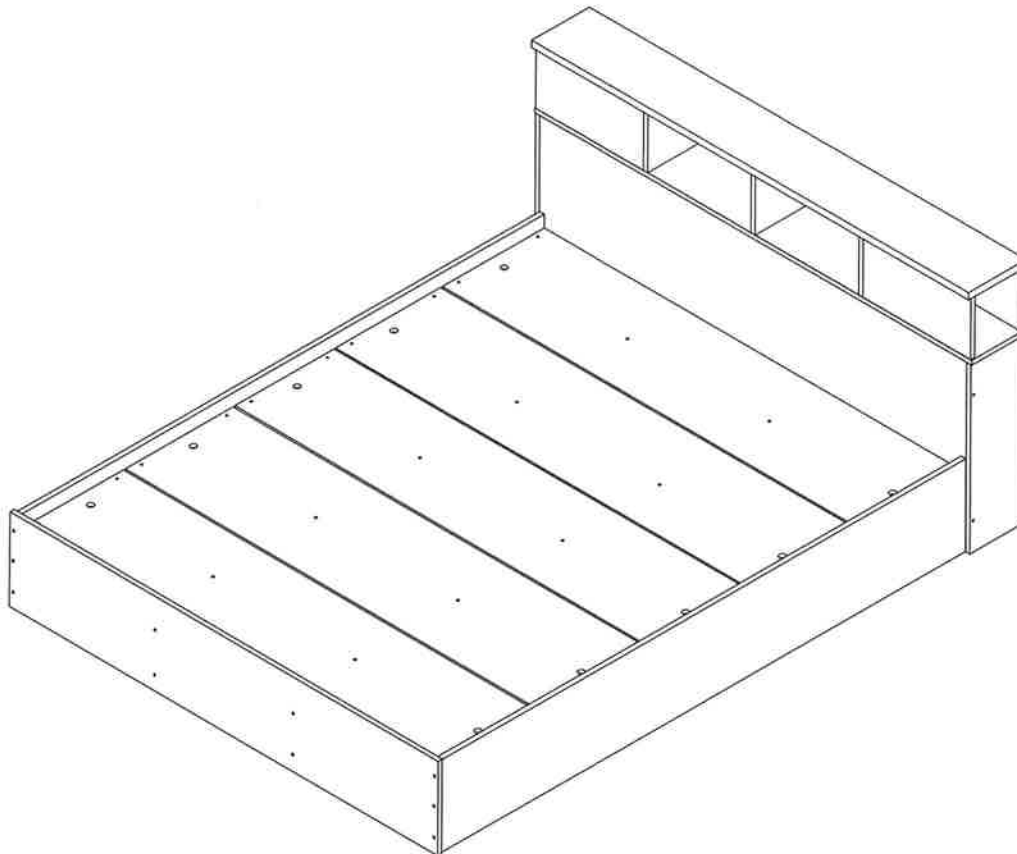

COMPLETE SET

NO	DESCRIPTION	QTY
A	TOP	01
B	LEFT SIDE BACK VERTICAL (Head)	01
C	CENTRE VERTICAL (Head)	01
D	LEFT SIDE FRONT VERTICAL (Head)	01
E	RIGHT SIDE BACK VERTICAL (Head)	01
F	CENTRE VERTICAL (Head)	01
G	RIGHT SIDE FRONT VERTICAL (Head)	01
H	CENTRE VERTICAL (Head)	01
I	CENTRE SHELF (Head)	01
J	LEFT SIDE (Head)	01
K	CENTRE SHELF SUPPORT (Head)	01
L	BACK VERTICAL (Head)	01
M	RIGHT SIDE (Head)	01
N	BACK (Head)	01
O	SIDE SUPPORT (Body)	02
P	SIDE (Body)	02
Q	CENTRE VERTICAL (Body)	02
R	FRONT VERTICAL (Body)	01
S	DECORATIVE BOARD	05

