

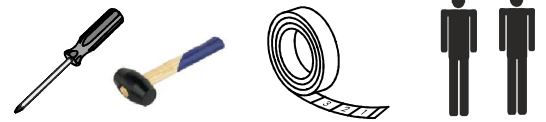

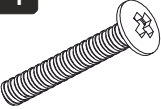

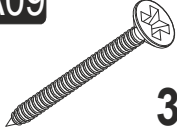

LAURA STUDY TABLE CT2

ASSEMBLY MANUAL

ACCESSORY LIST

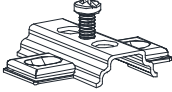

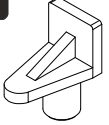
A14  2x	A09  35 x	A10  8x	A16  20x 4x	A24  1x
A12  2x	A13  2x	A28  20x	A77  2x	A23  12x

GENERAL VIEW

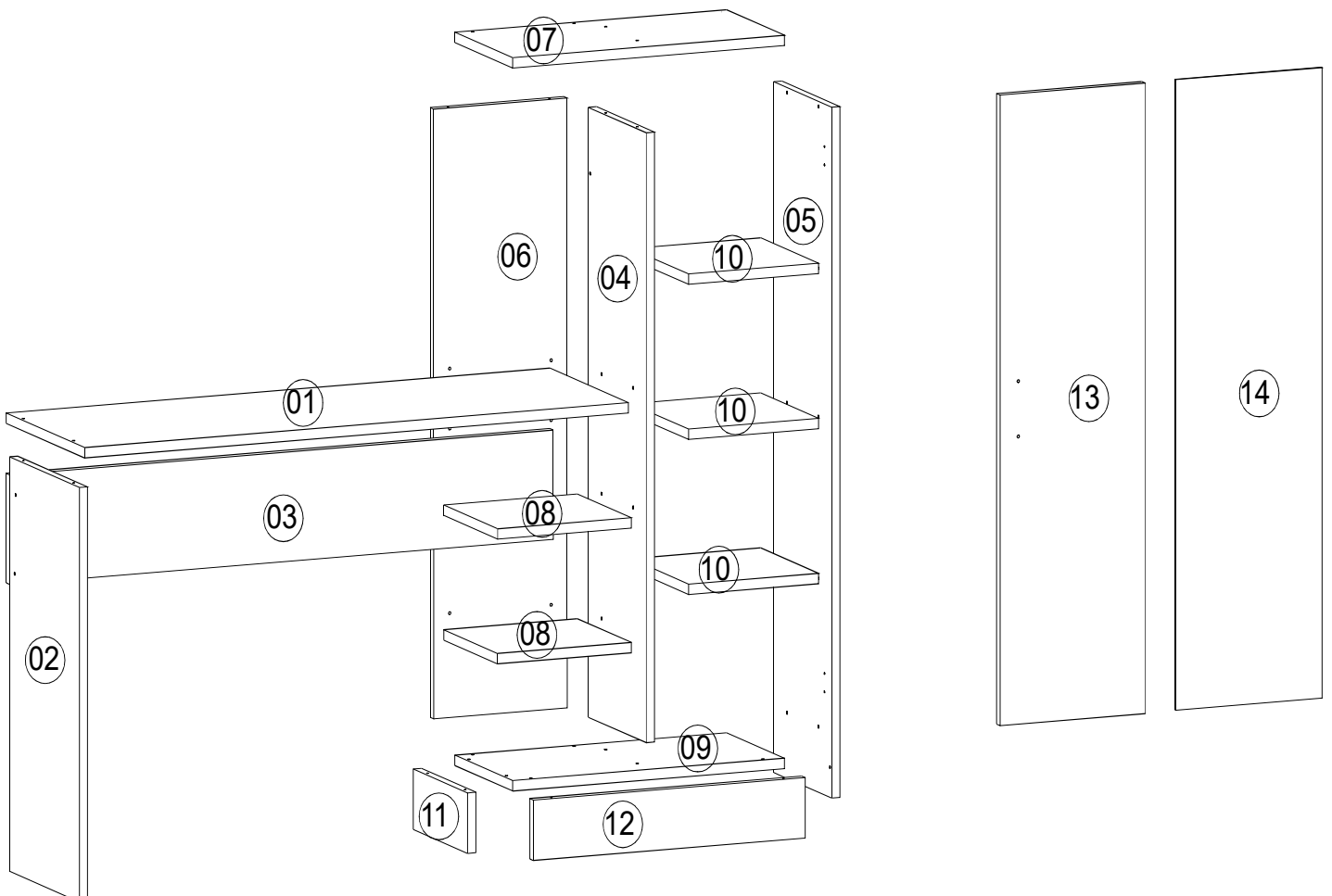

ASSEMBLY MANUAL

