

A	B	C	D	A	B	C	D		
1	KR1-022	2029	804	3/3	8	KR1-320	776	460	2/3
2	KR1-020	2029	804	3/3	9	KR1-321	776	455	2/3
3	KR1-110	2155	608	1/3	10	KR1-410	1568	80	2/3
4	KR1-111	2155	608	1/3	11	KR1-409	1568	80	2/3
5	KR1-106	2042	460	1/3	12	KR1-907	1634	791	3/3
6	KR1-318	1568	583	2/3	13	KR1-922	422	791	3/3
7	KR1-319	1568	566	2/3	14	DR-771	771		1/3
					15		1567	20	1/3

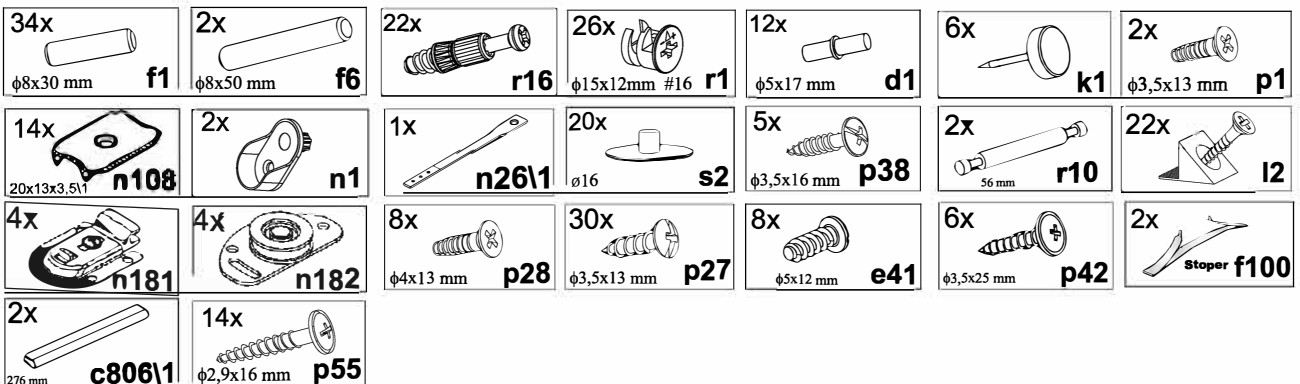

1

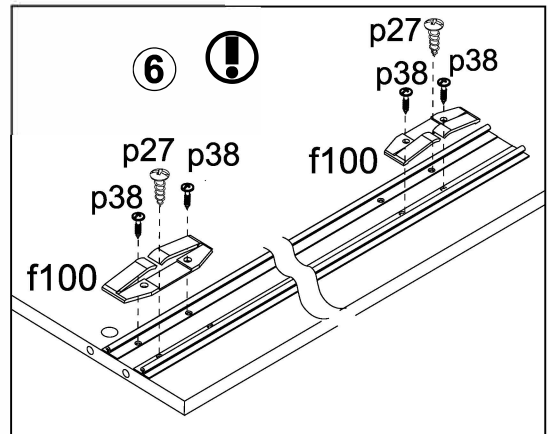
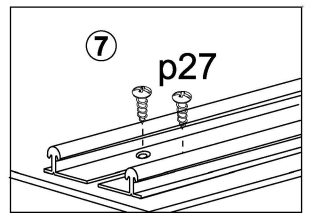
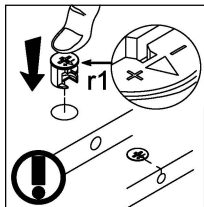
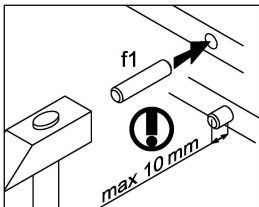
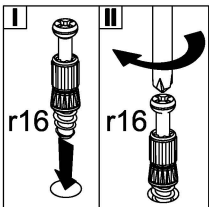
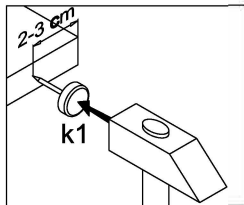
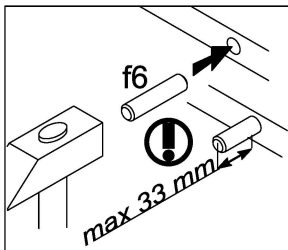
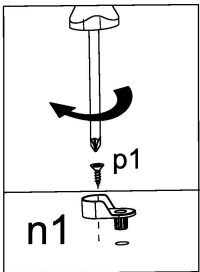
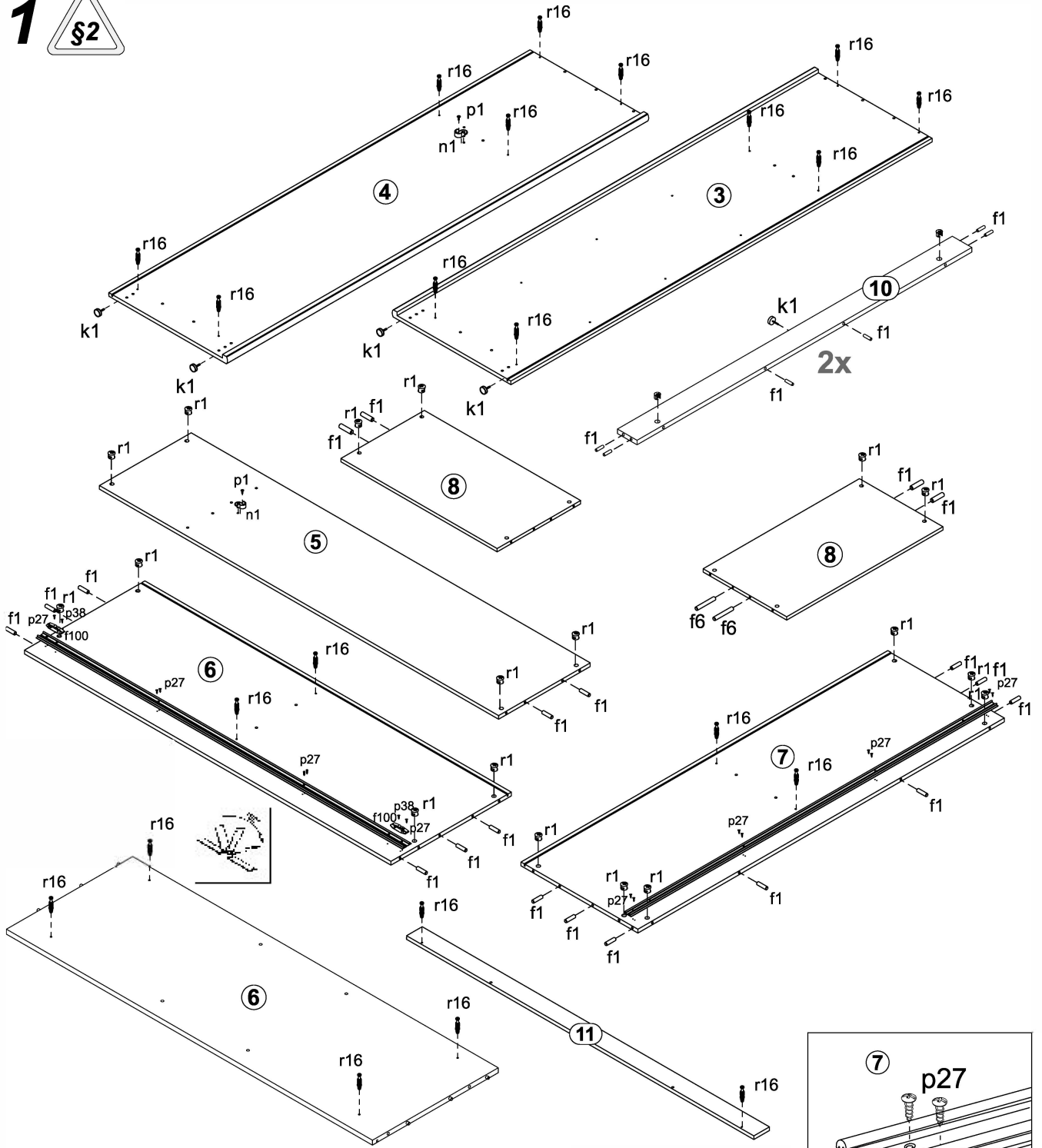

2

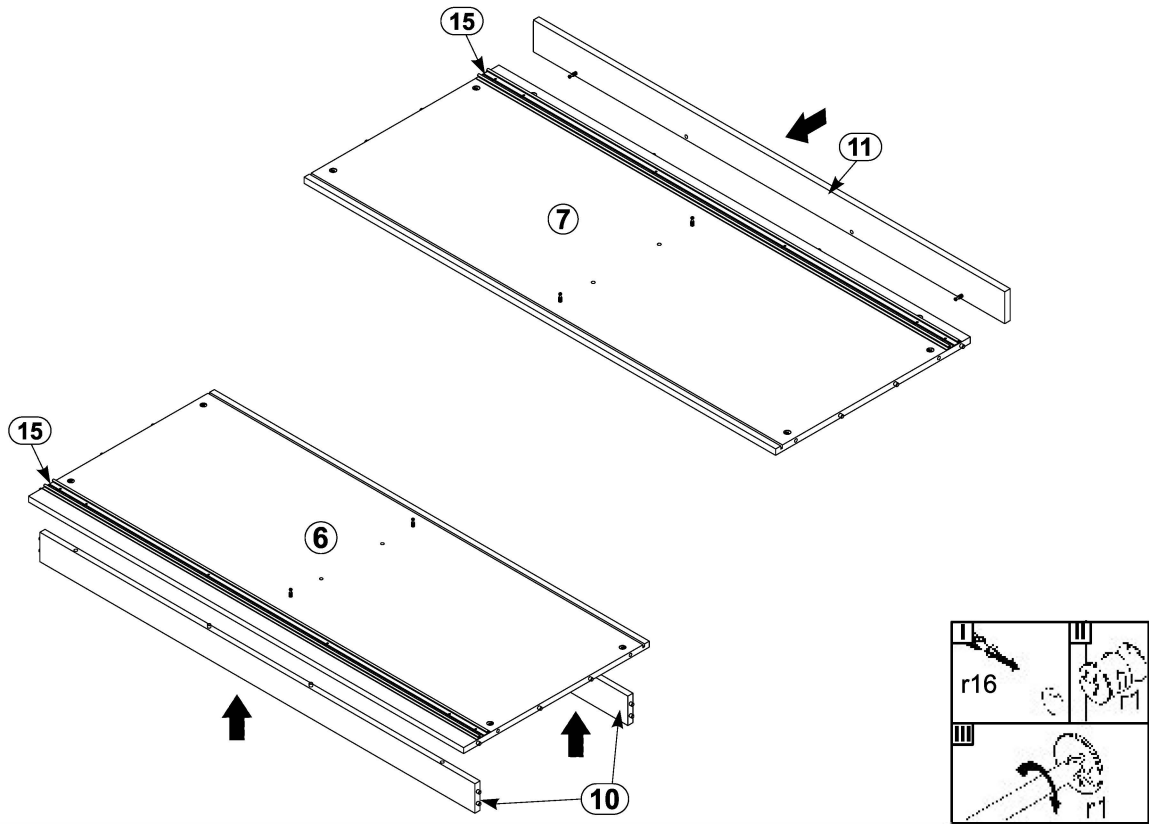

3

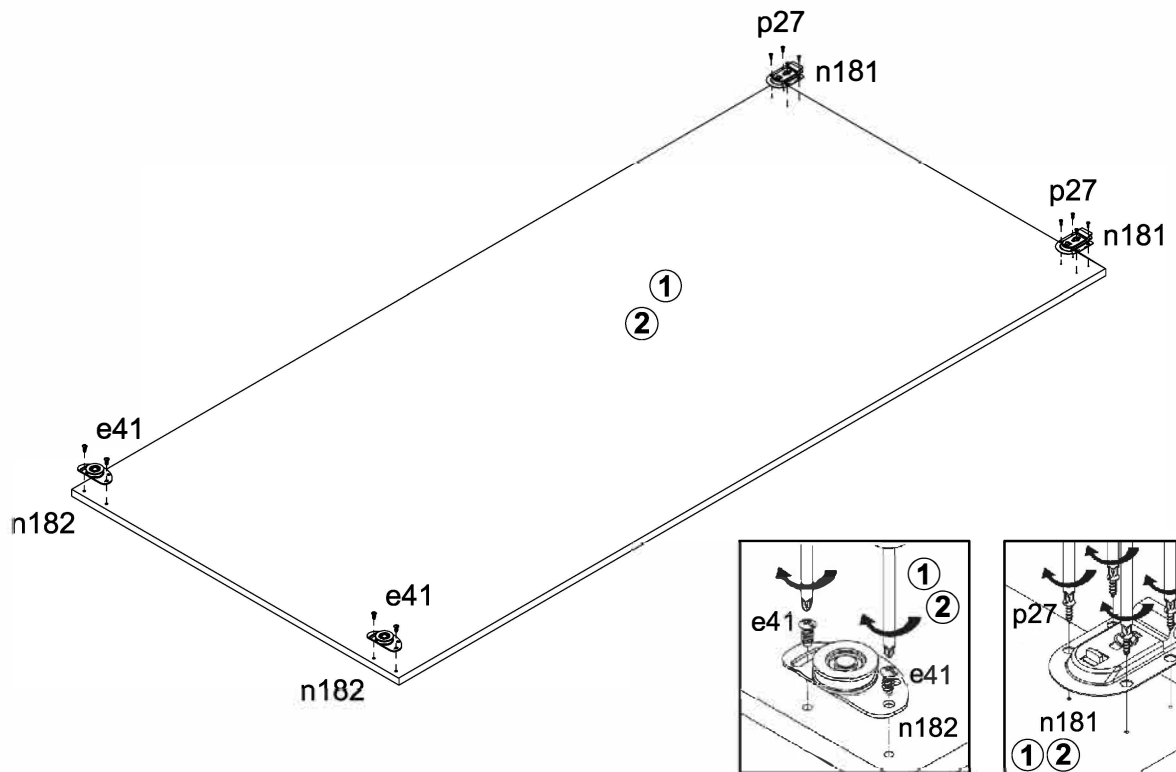

4

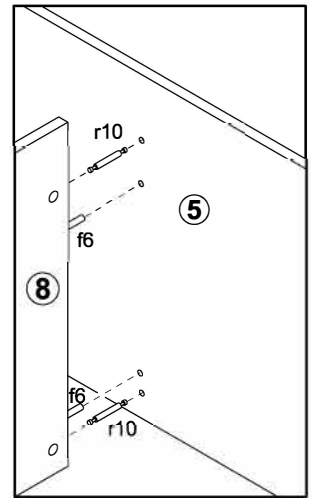
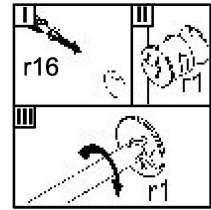
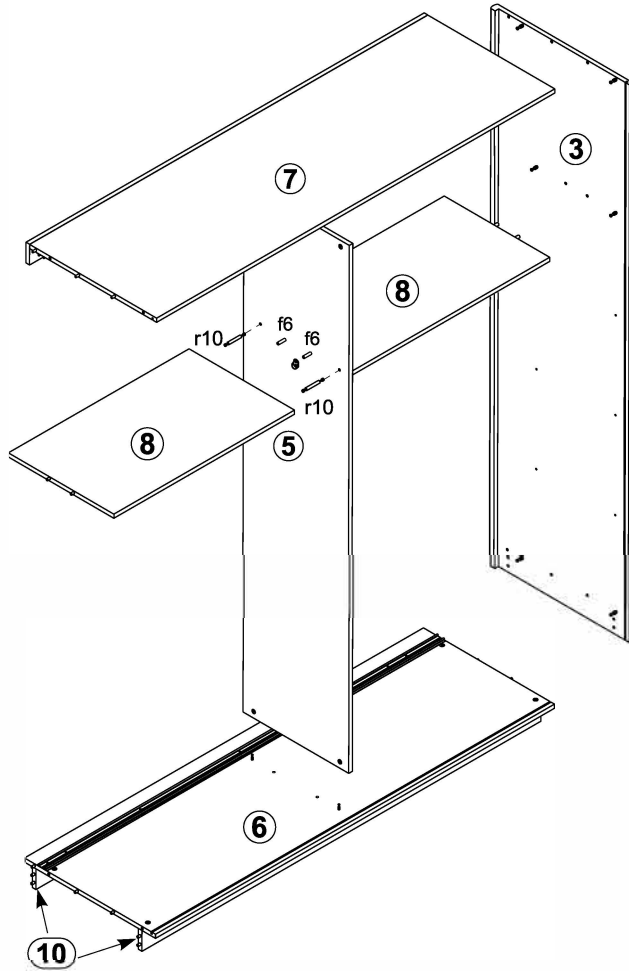
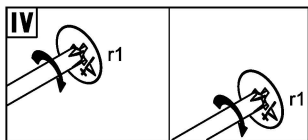
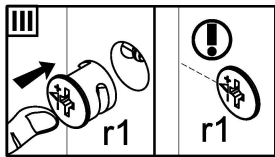
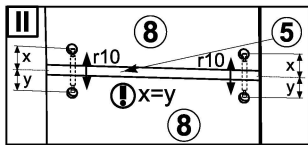
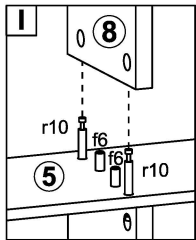

5

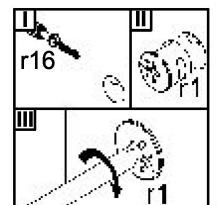
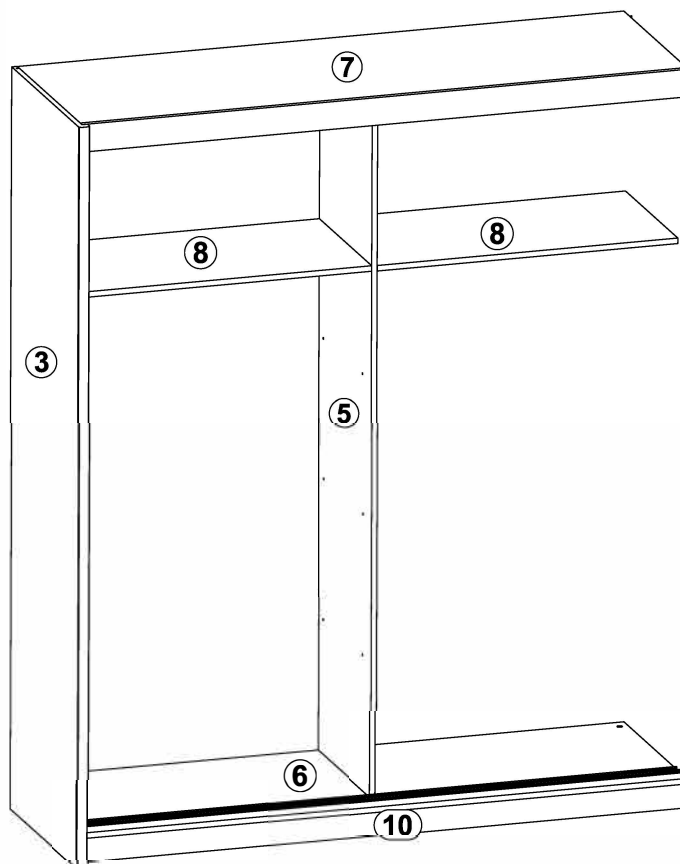

6

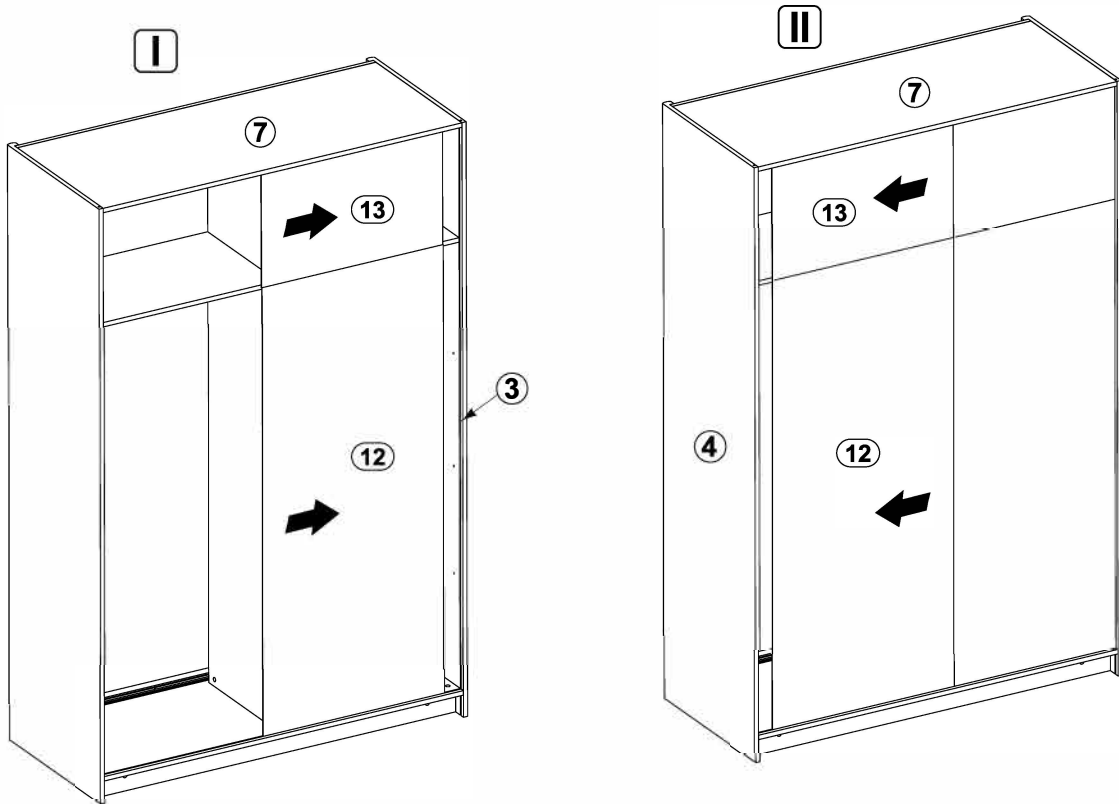

7

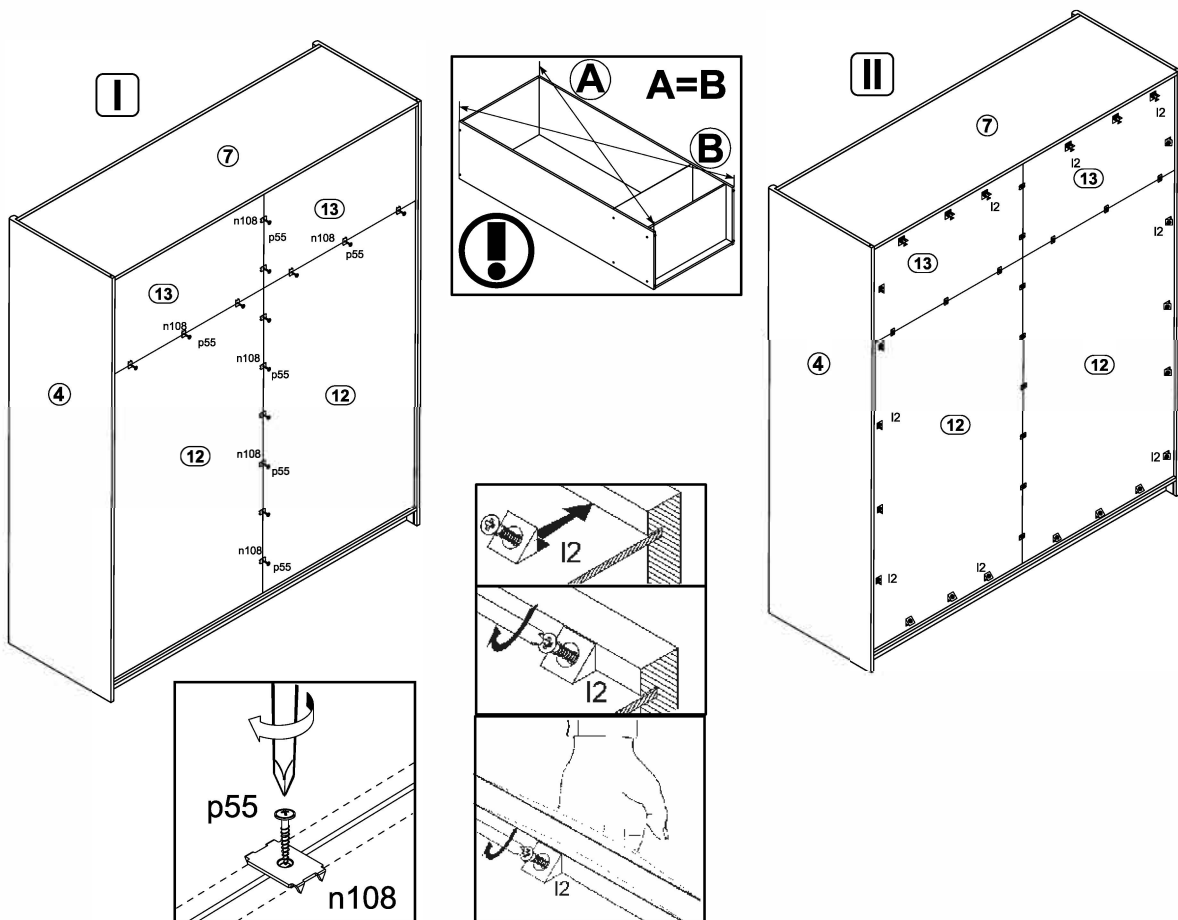

8

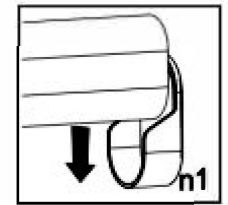
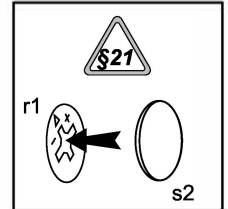
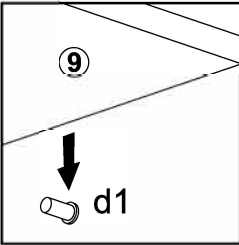
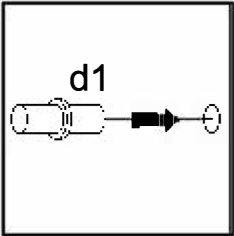
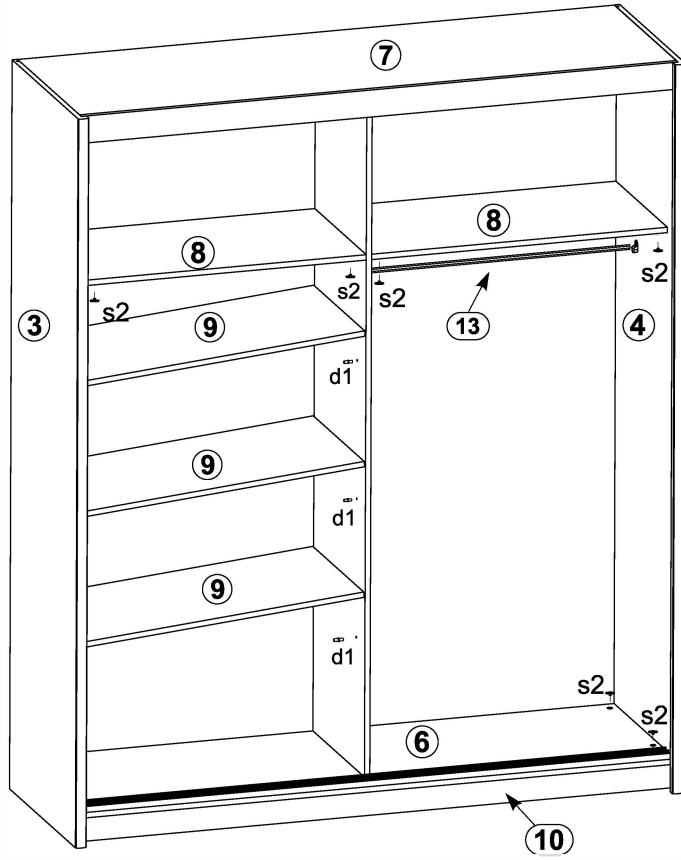

9

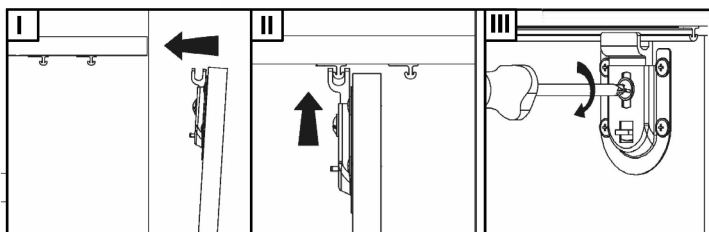
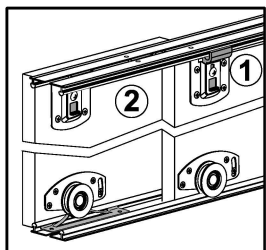
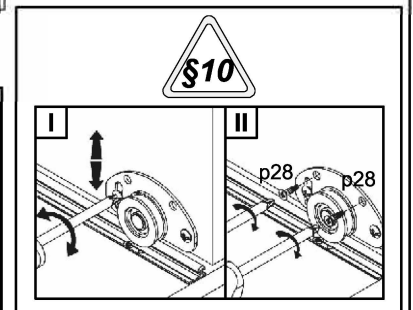
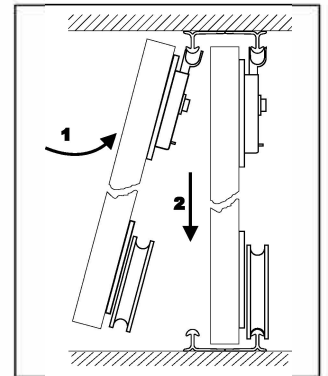
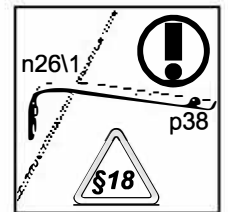
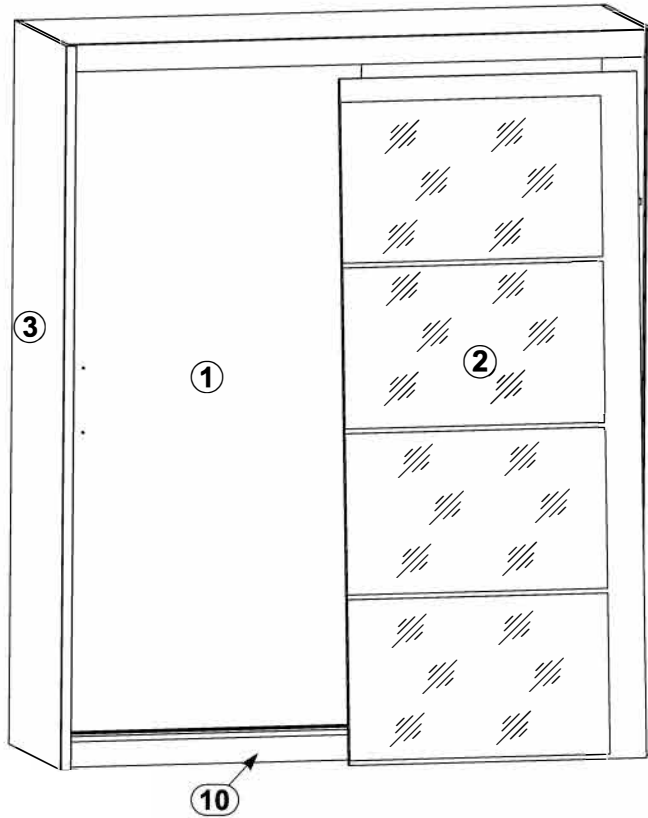
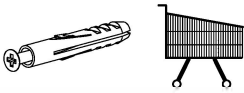

10

