

# LUSIA 175

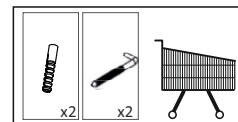

# I

## Wall Cabinet REG1D

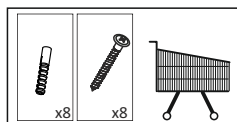
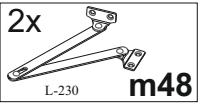
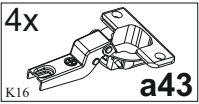
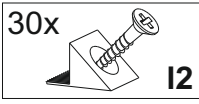
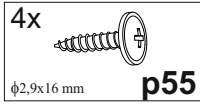
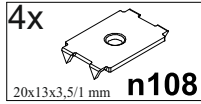
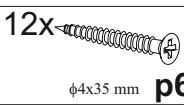
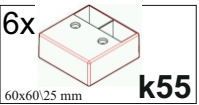
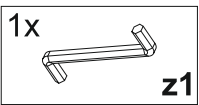
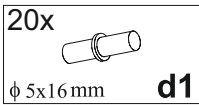
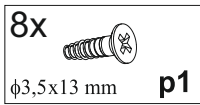
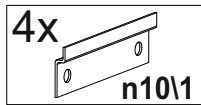
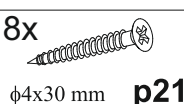
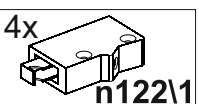
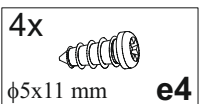
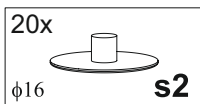
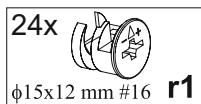
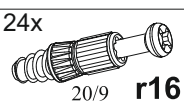
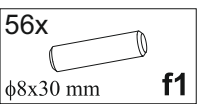
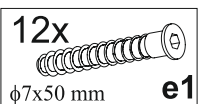
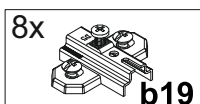
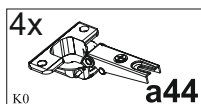
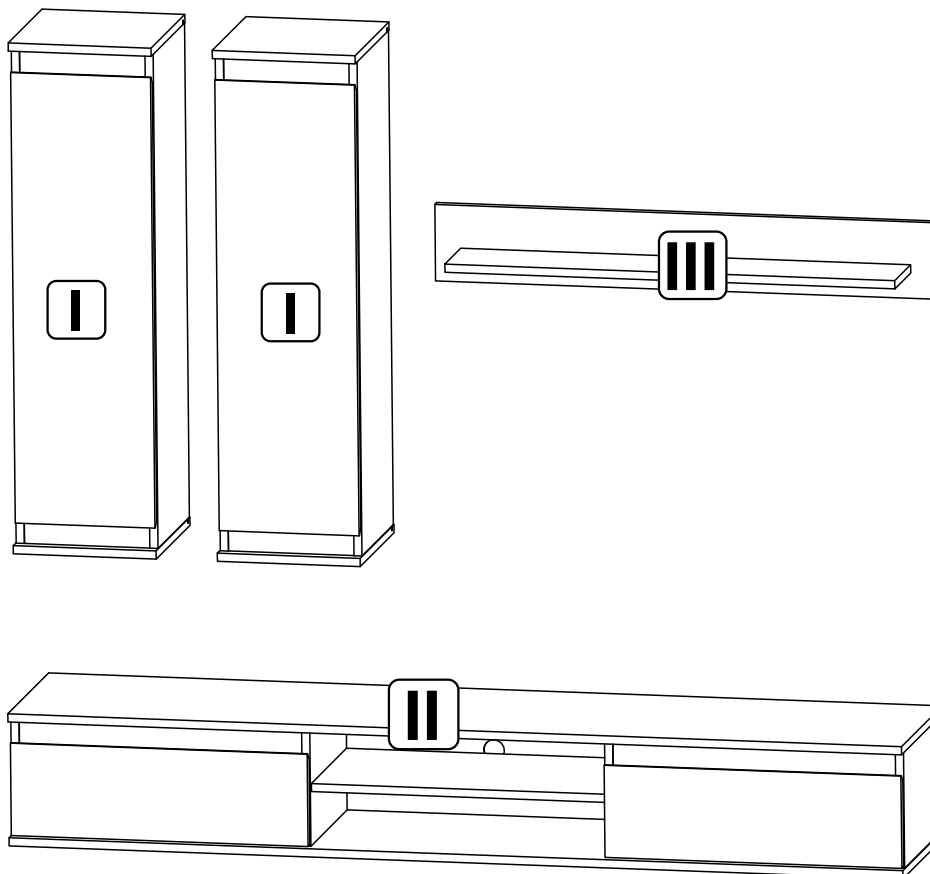
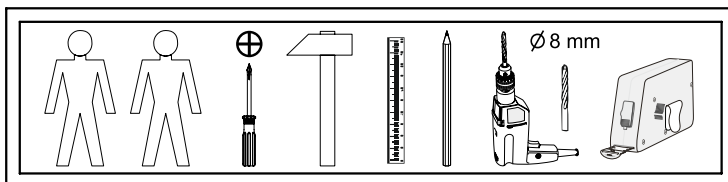
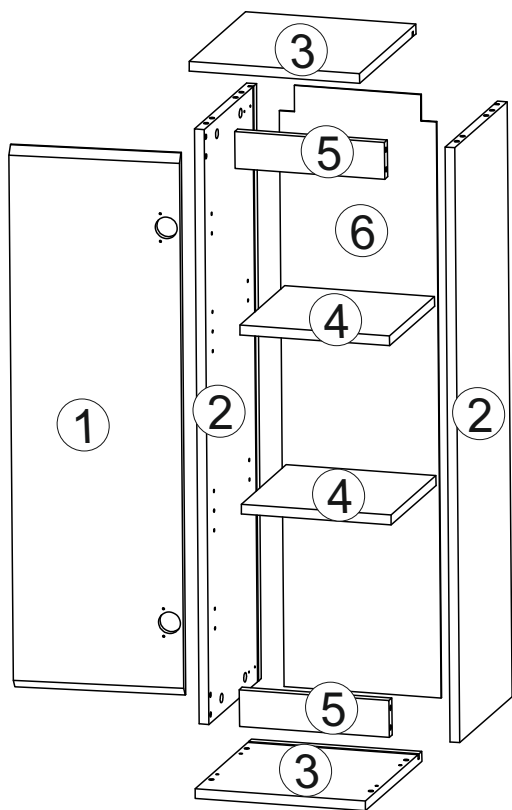

2x



A	B	C	D
1	LU1-001	884	274 1/2
2	LU1-101	970	284 1/2
3	LU1-201	280	306 1/2
4	LU1-301	244	246 1/2
5	LU1-401	246	60 1/2
6	LU1-901	258	982 1/2

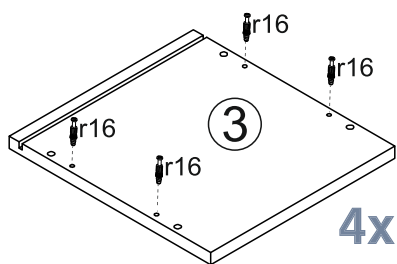
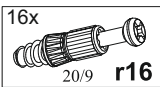
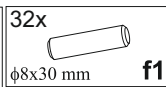
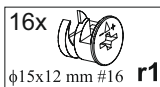

4x

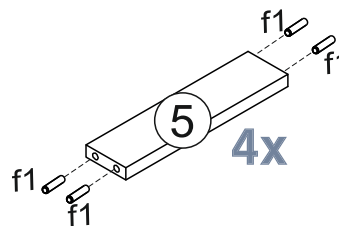

4x

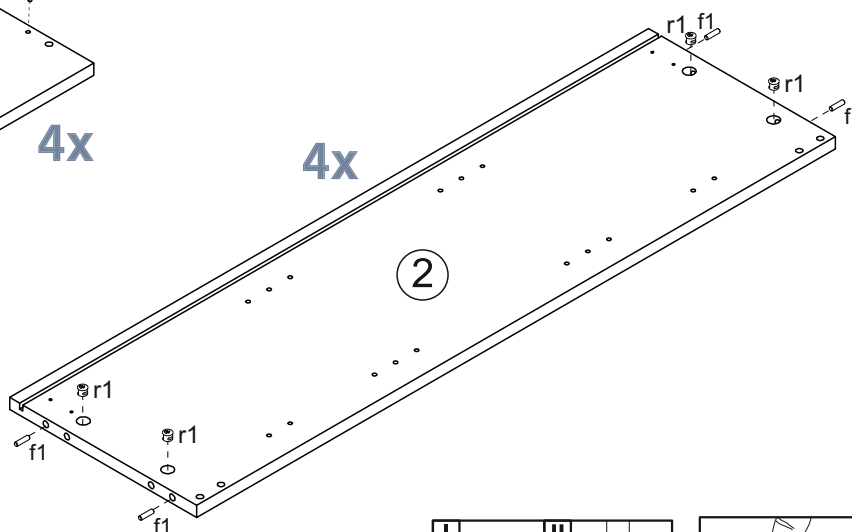

4x

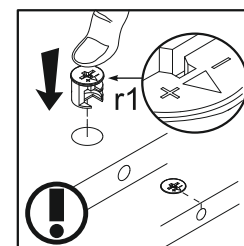
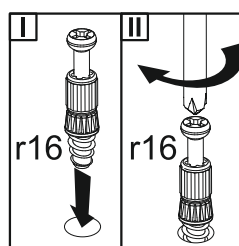
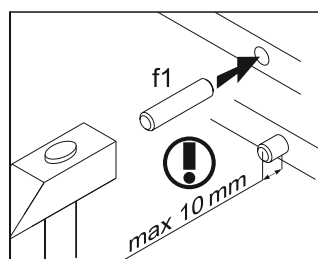

# 2



## 2x

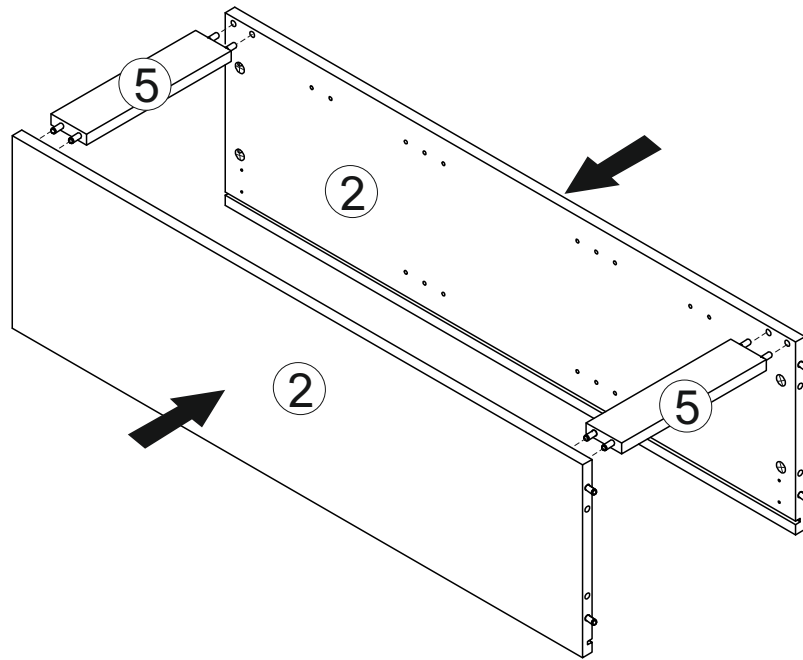

# 3

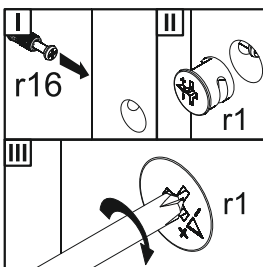
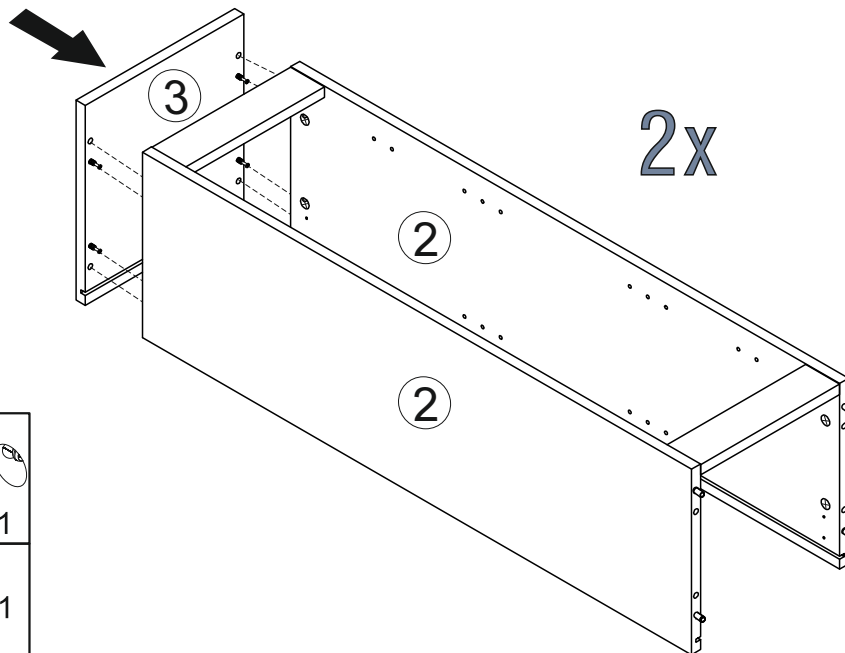

# 4

# 2x

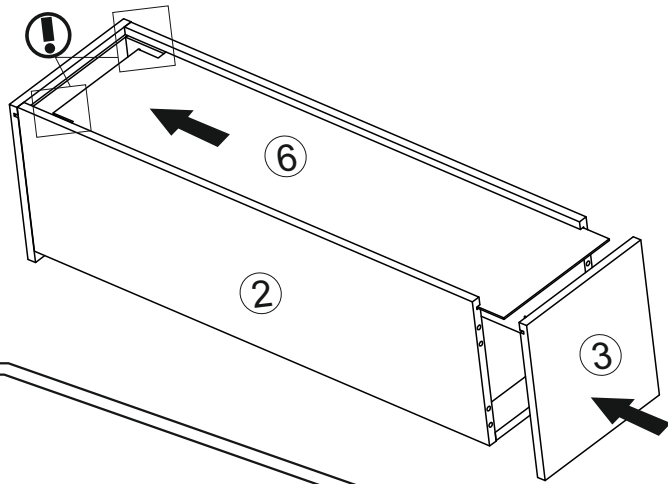
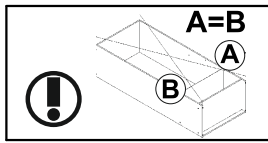

# 5

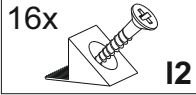

# 2x

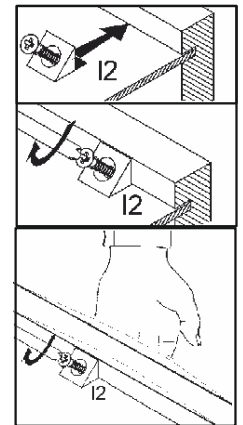
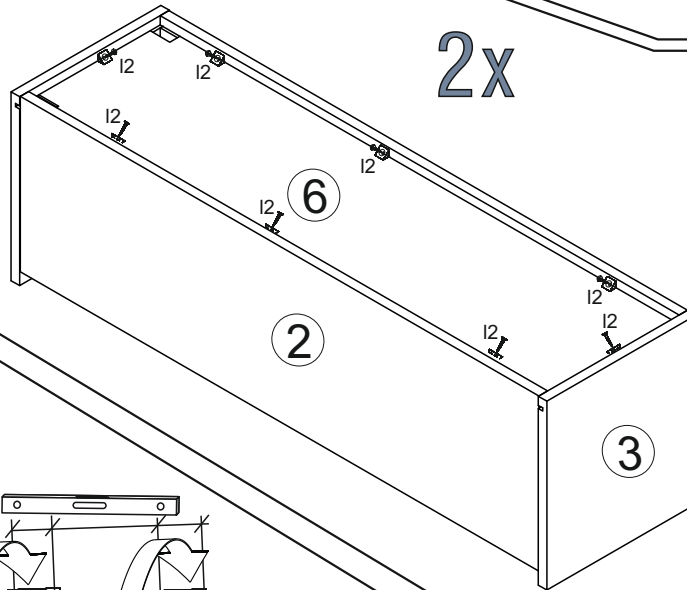
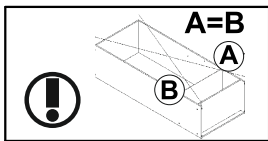

# 6

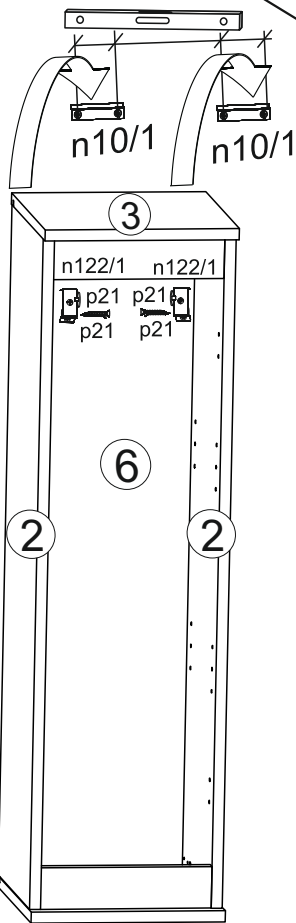
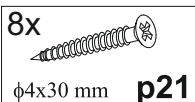
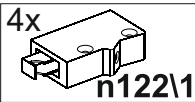
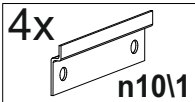
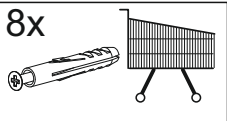

# 2x

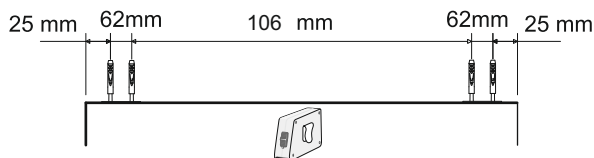
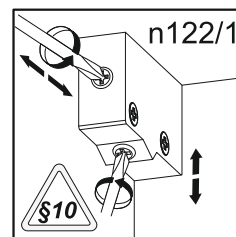
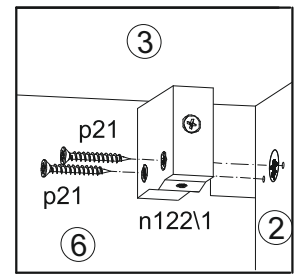
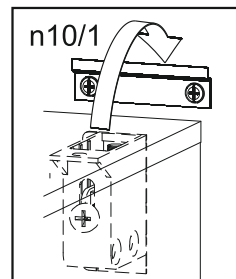
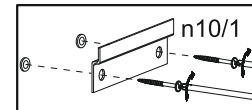
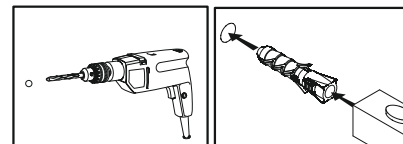

7

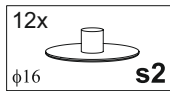
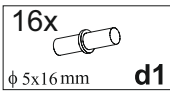
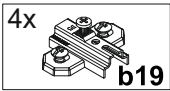
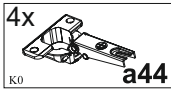

2x

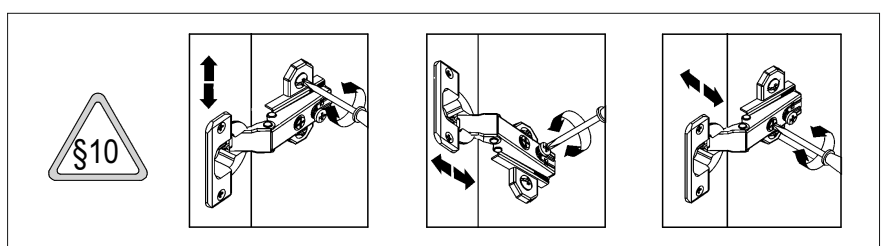
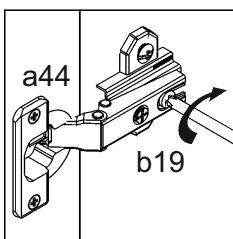
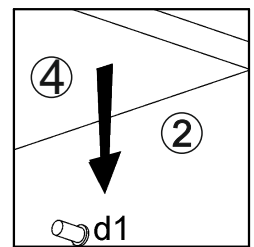
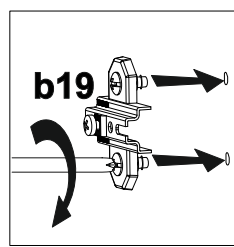
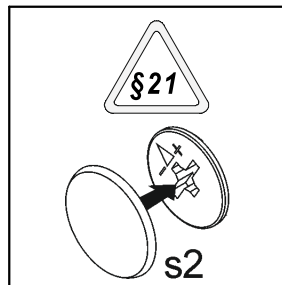
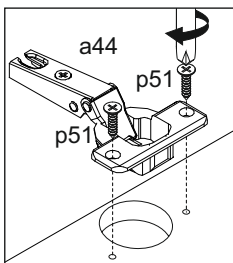
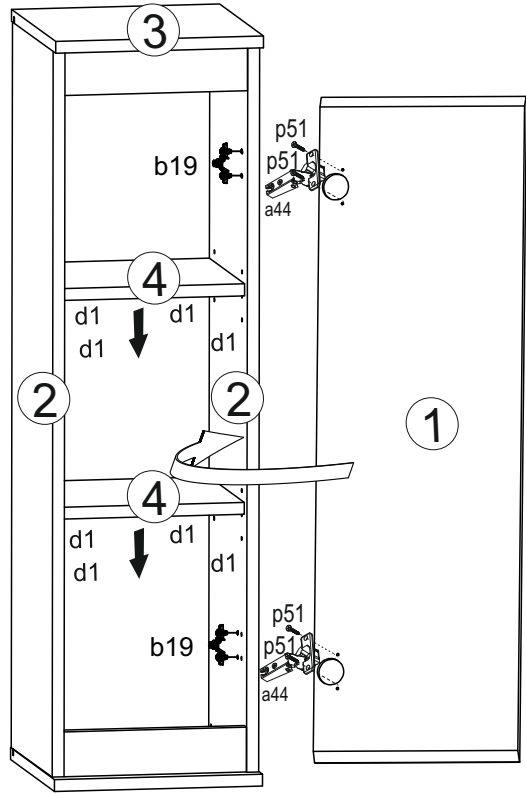
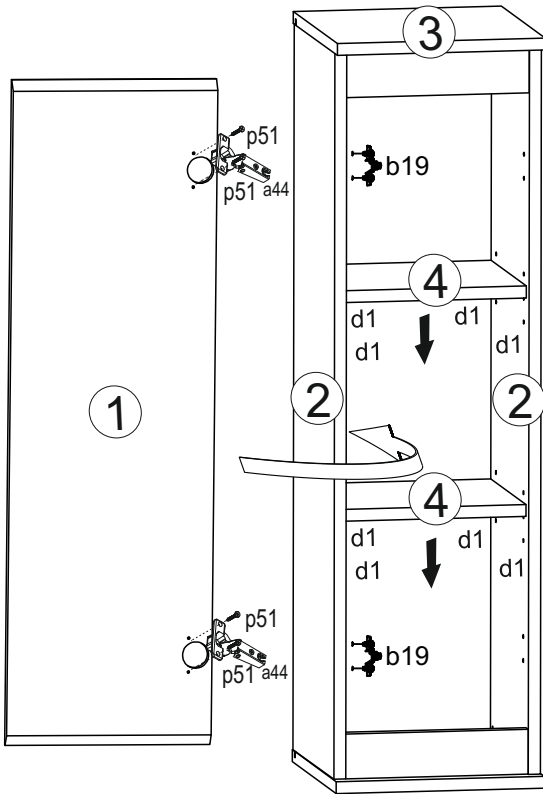



# TV stand

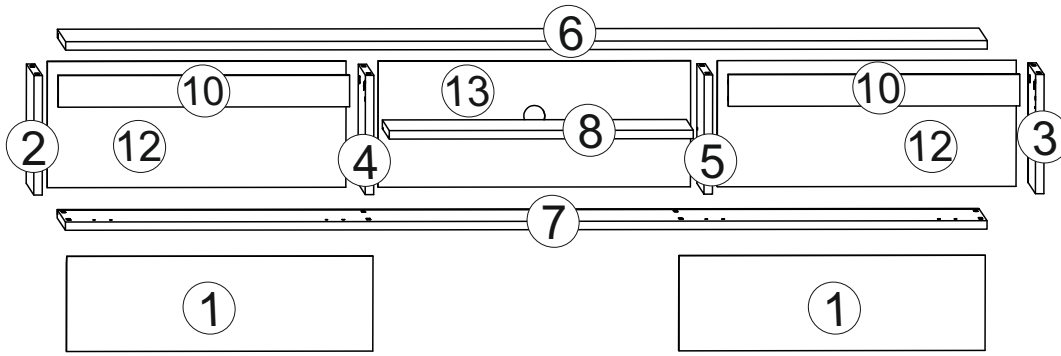

A	B	C	D
1	LU1-002	582	181
2	LU1-102	227	348
3	LU1-103	227	348
4	LU1-104	227	328
5	LU1-105	227	328
6	LU1-202	1752	370

A	B	C	D
7	LU1-203	1752	370
8	LU1-302	576	318
10	LU1-402	554	60
12	LU1-902	568	240
13	LU1-903	594	240

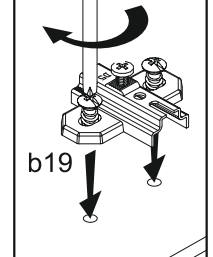
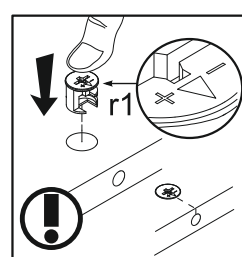
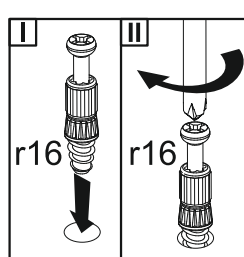
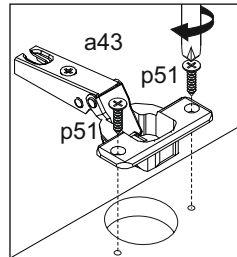
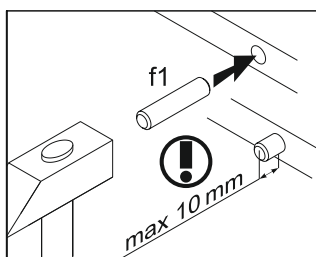
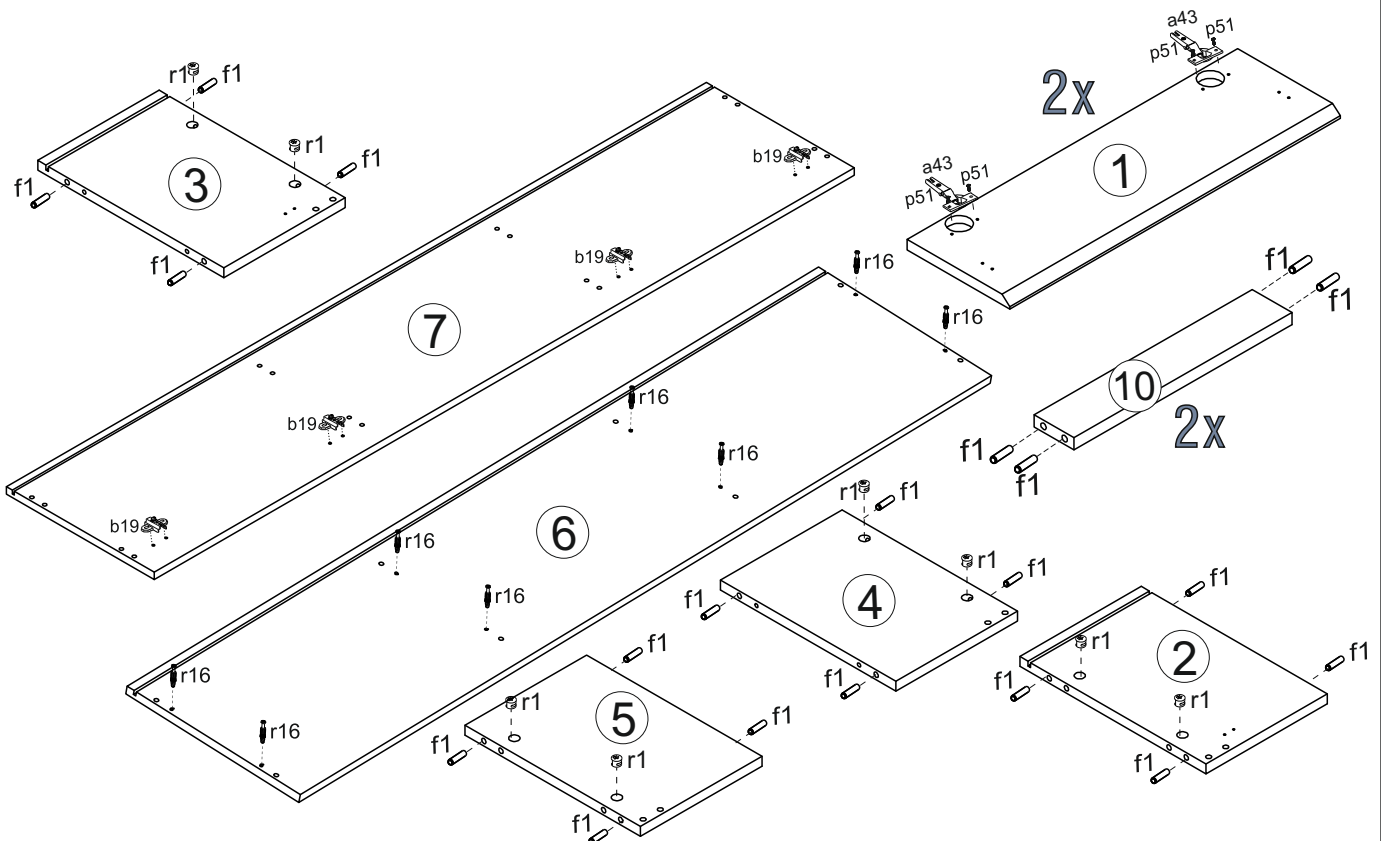
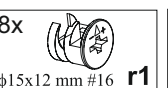
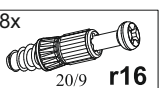
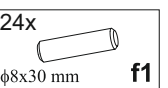
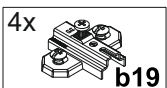
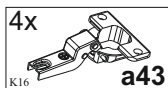

# 2

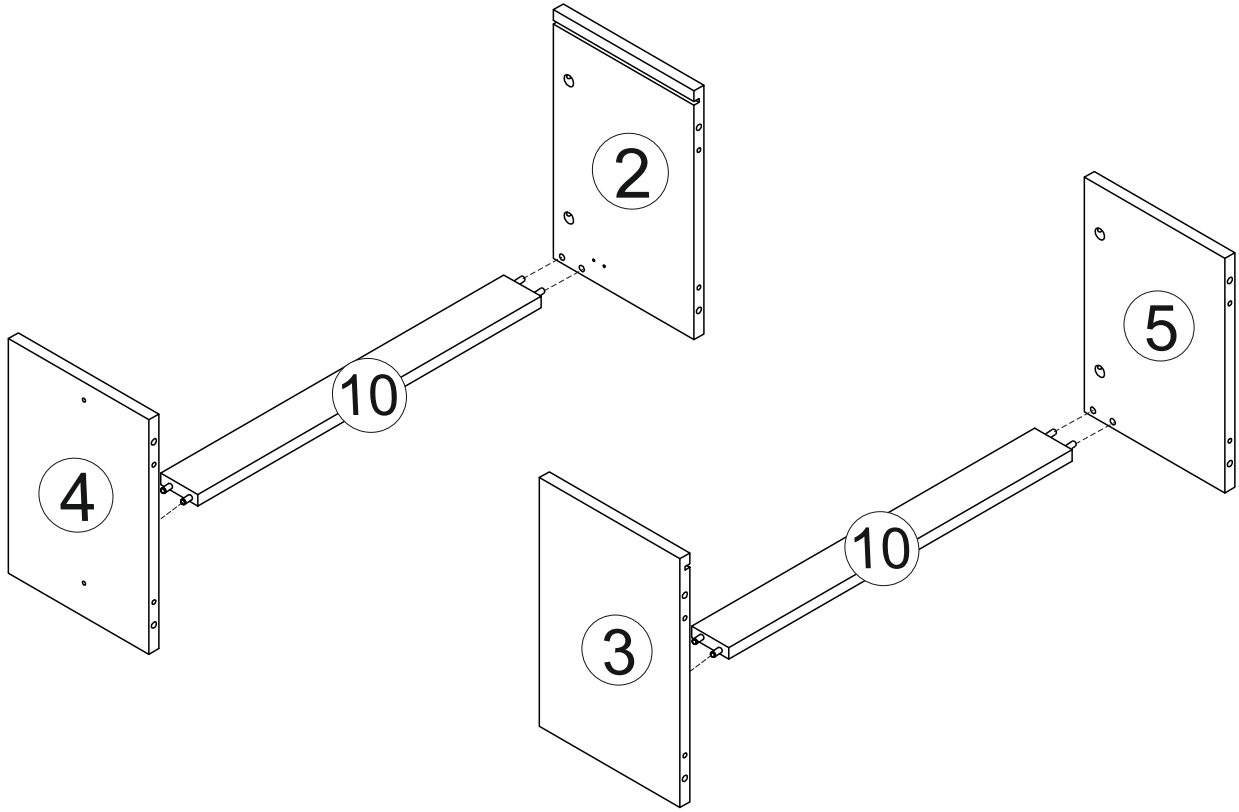

# 3

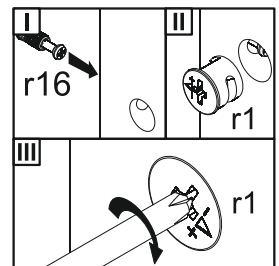
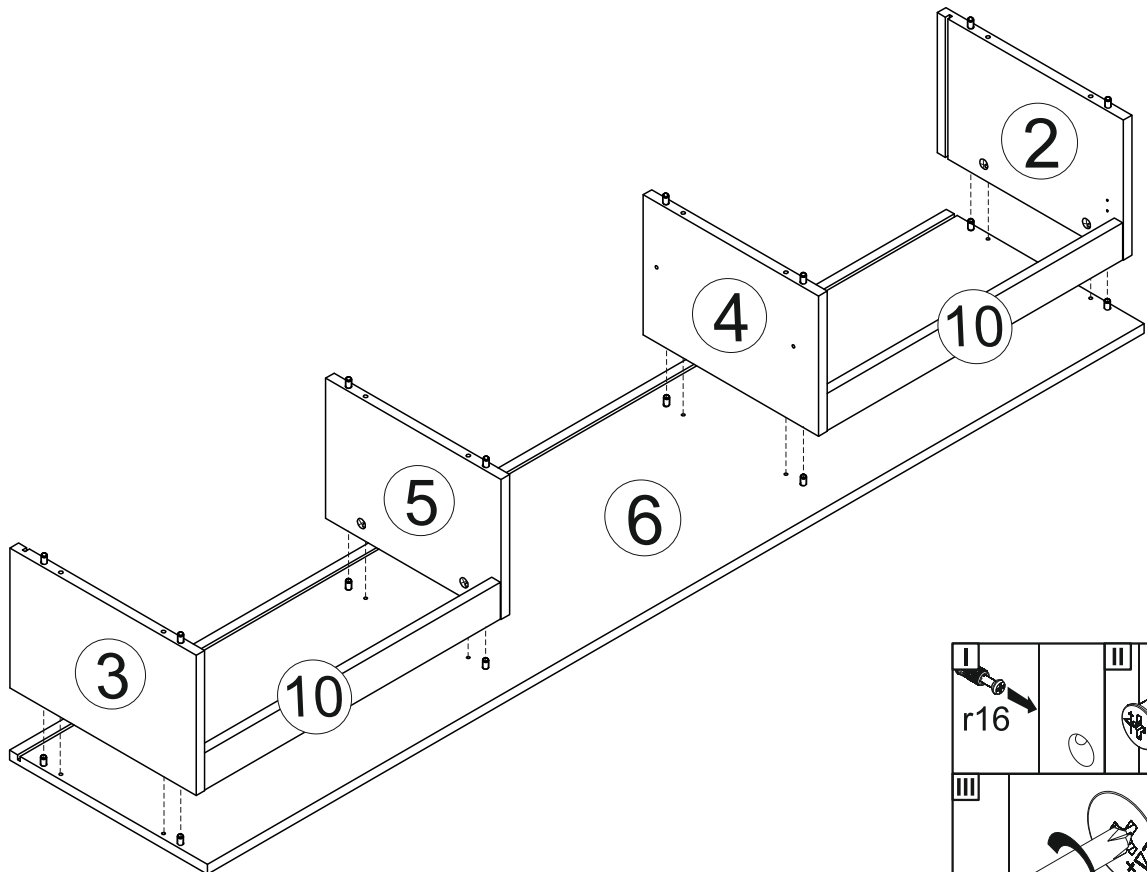

# 4

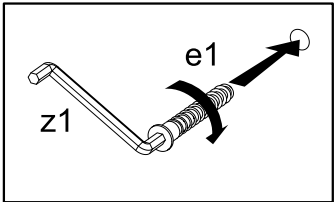
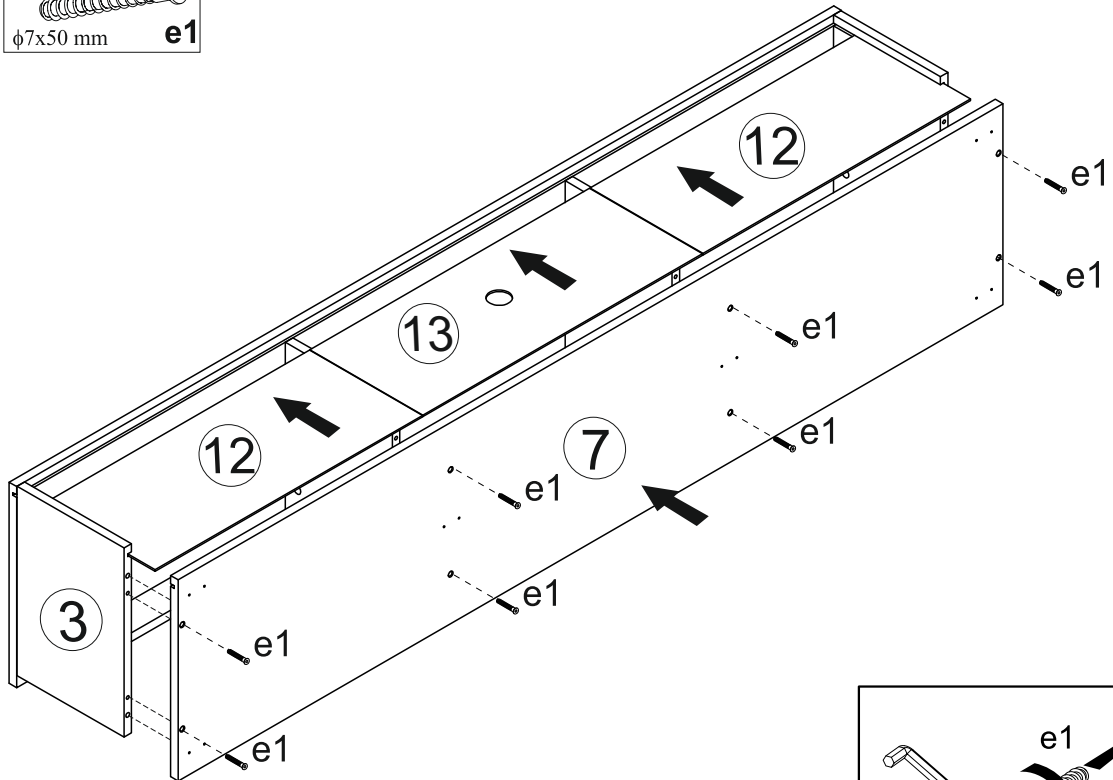
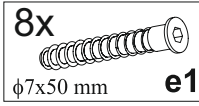

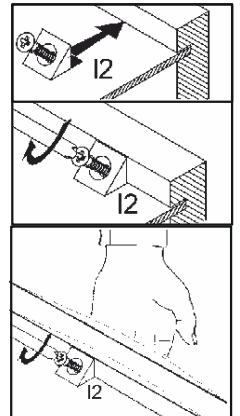
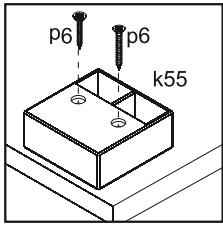
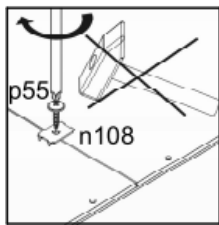
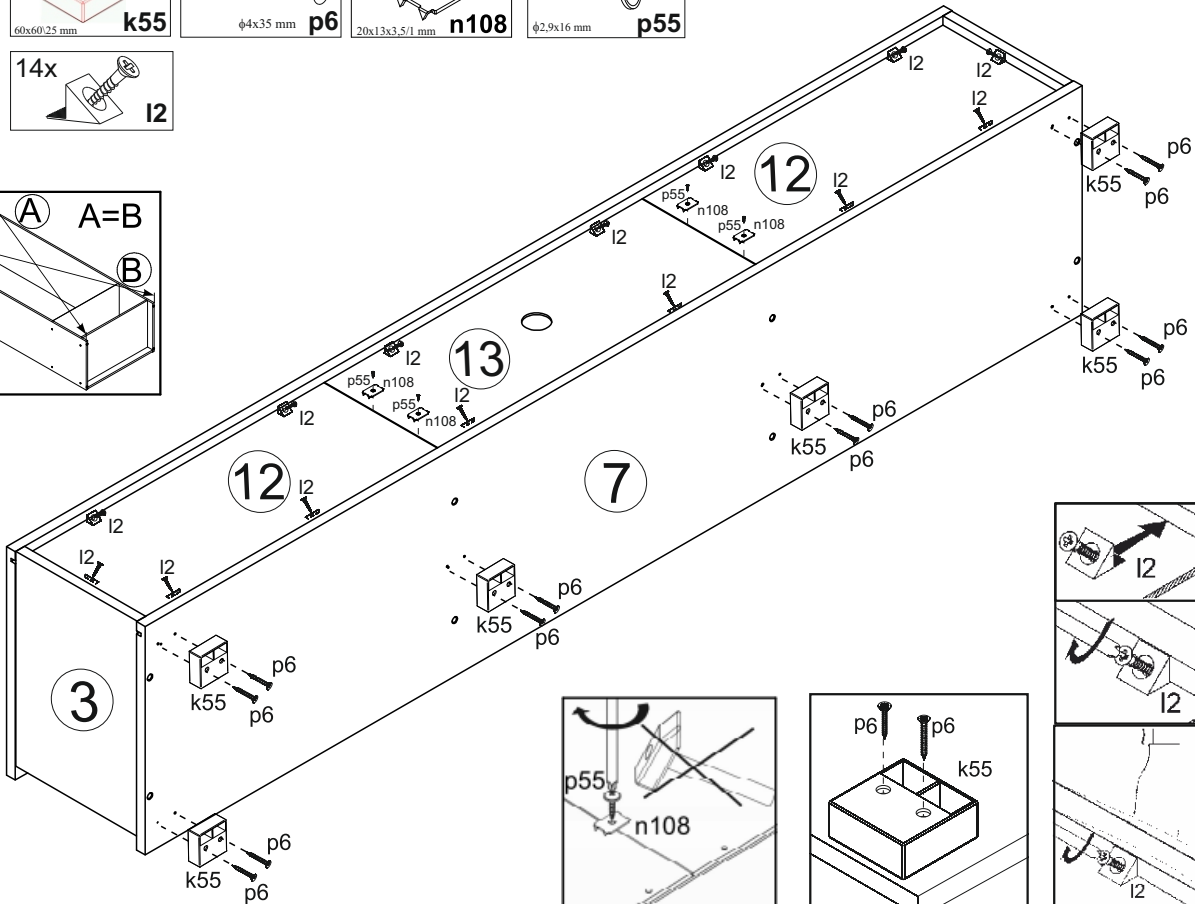
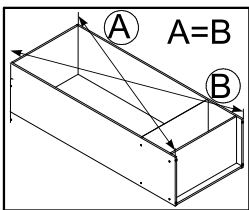
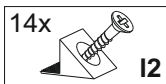
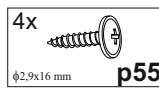
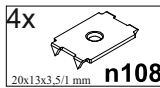
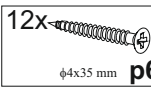
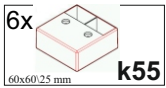

# 5







# 6

8x   $\phi 3,5 \times 13$  mm p1

4x   $\phi 5 \times 16$  mm d1

2x  L-230 m48

8x   $\phi 16$  s2

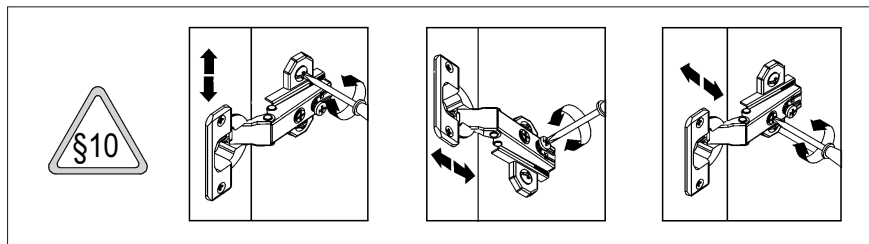
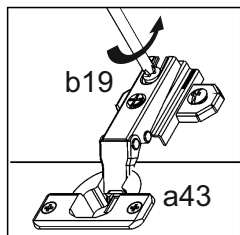
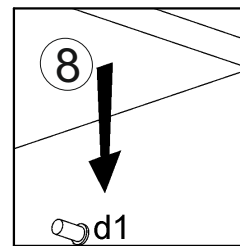
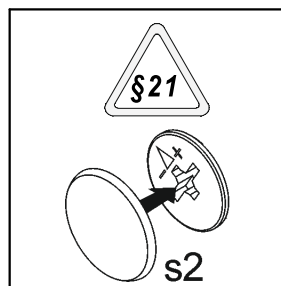
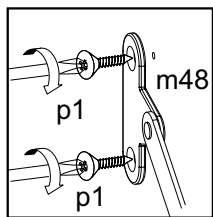
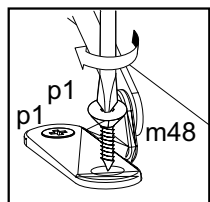
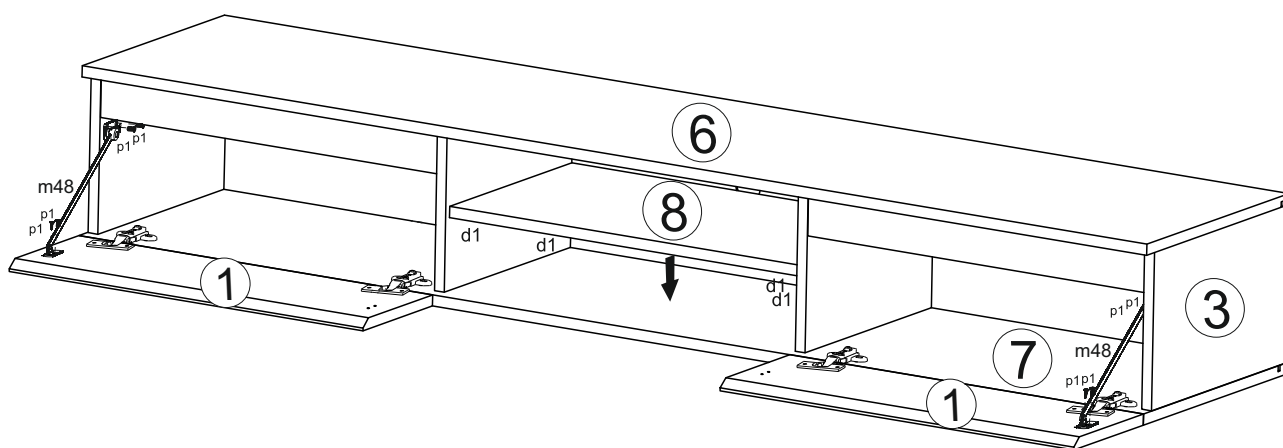

**Shelf**

max  
3kg

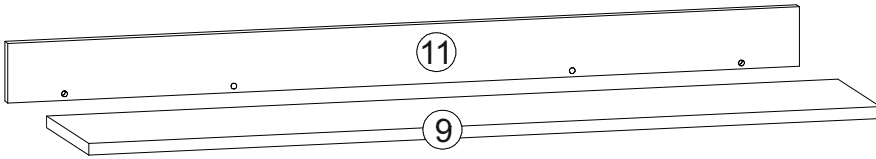

A	B	C	D	
9	LU1-303	882	144	2/2
11	LU1-403	982	150	2/2

