

Bedbase Assembly Instruction

197-000111

Devices:

For Single Bedbase



x1 Piece
headboard connection
screw



x1 Piece
Headboard
Connection Device



x4 Piece
Bedbase Legs

For Double Bedbase



x2 Piece
headboard
connection screw



x2 Pcs
Headboard
connection device



x8 Pcs
bedbase leg



x1 Pcs
Bedbase Connect

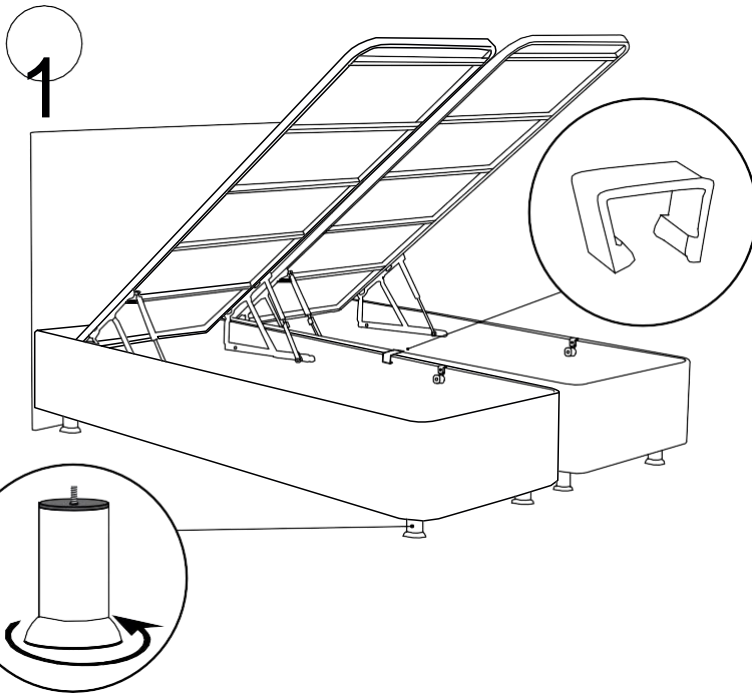

ATTENTION!

You should pay attention to the bedbase cover.

Make sure that there are no children around during the installation.

When you turn the bedbase on its side, the lid may suddenly open and slam. That's why you have to open the lid first and then turn the base on its side.

When installing the bedbase legs, you need to pierce the fabric under the bedbase at the level of the holes on the metal profile.

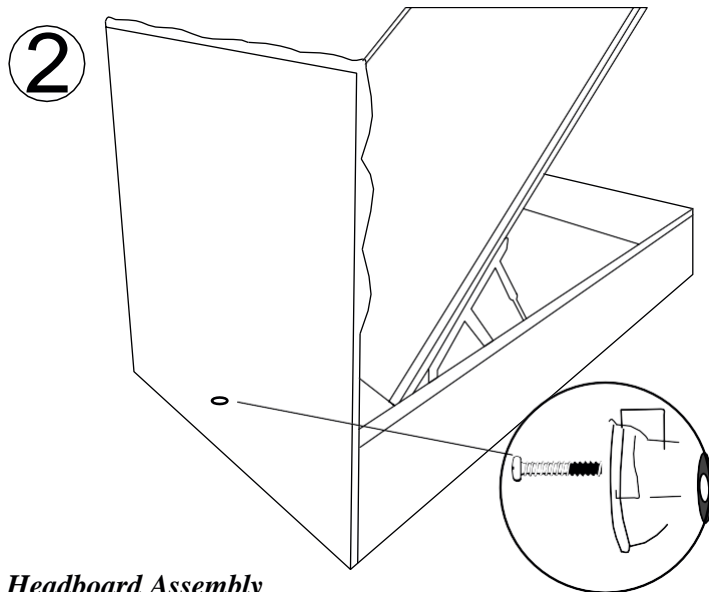

Headboard Assembly

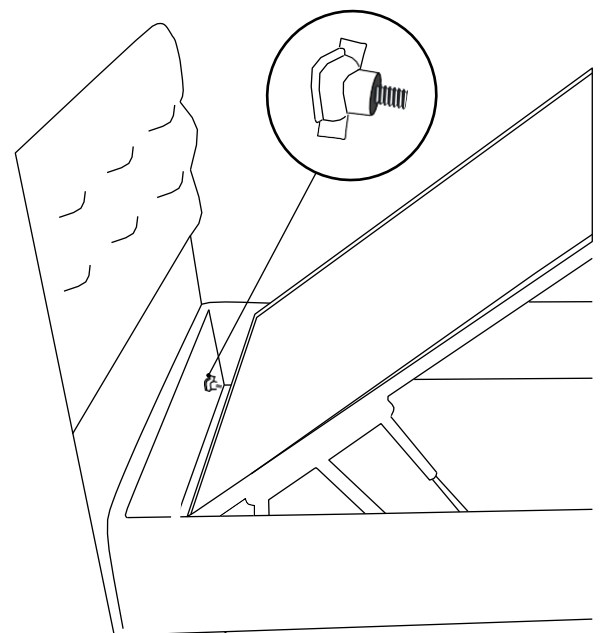

Mark the connection points of your bedbase or cot on the header with the help of a pencil. drill the head through the marked points and fix it in place with mounting screws.