

ASSEMBLY INSTRUCTION

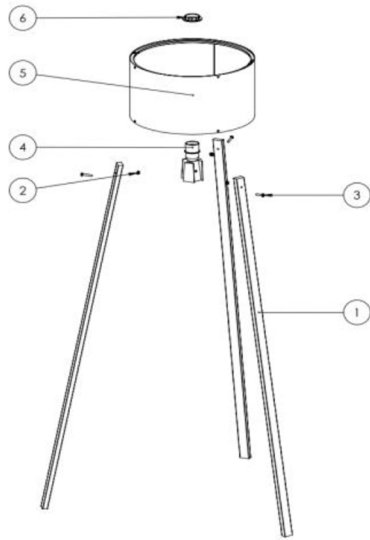

Packaging content:

- | | |
|---|----------|
| 1 Wooden foot | 3 Pieces |
| 2 Nut | 3 Pieces |
| 3 Bolt (star head) | 3 Pieces |
| 4 Lampholder and Body (assembled) | 1 Piece |
| 5 Lampshade head (De-mounted) | |
| 5-1 Subframe (Disassembled) | 2 Pieces |
| 5-2 Upper frame (Disassembled) | 2 Pieces |
| 5-3 Lampshade head cover (De-assembled) | 1 Piece |
| 6 Socket nut | 1 Piece |

1

Assembly Instruction;

- 1) Please confirm with the quantity and content information of the parts coming out of the product packaging.
- 2) Assemble the "1" parts one by one with the "3" connection bolt so that the 2 parts remain inside the part numbered "4".
- 3) Assemble the part no. "5" in 3 different assembly sequences as in "Figure A / B / C".

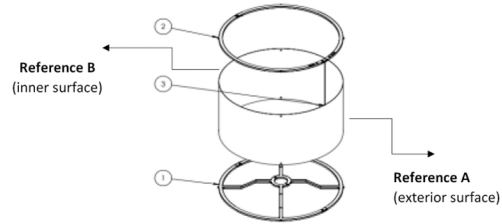

With the "Reference A" surface of part "5-3" facing outward, the following Combine as in the pictures.

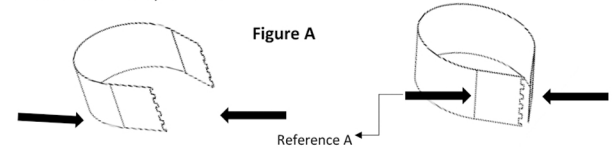

After bringing the piece "5-3" to the stage in "figure A", the ring made from the inside locked by the locking mechanism.

Figure B

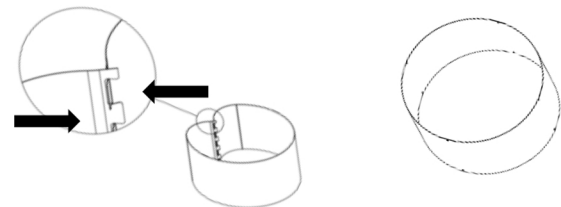

2

The part "5-2" is locked from the double-sided locking mechanism as in "Figure C".

Figure C

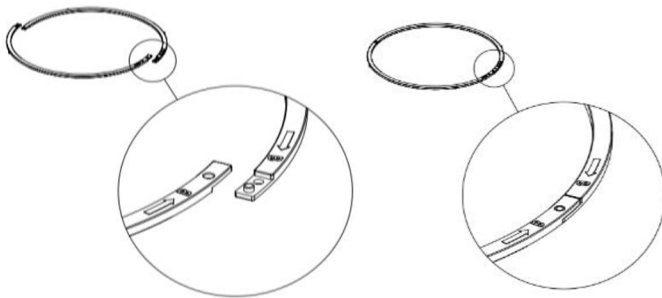

The part "5-3" is locked from the double-sided locking mechanism as in "Figure D".

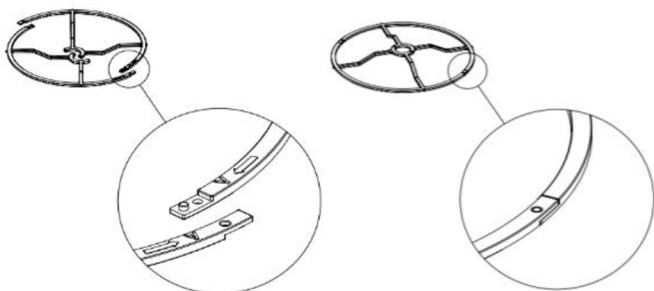

3

The assembled "5-2" and "5-1" parts are mounted through the "5-3" holes.

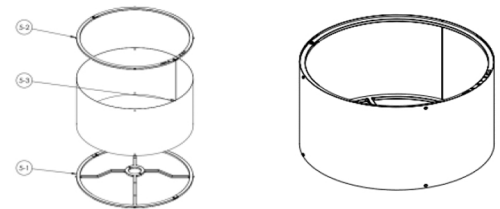

After the "5" part is mounted to the "4" part, the "6" part is "4". It is mounted by screwing to the part.

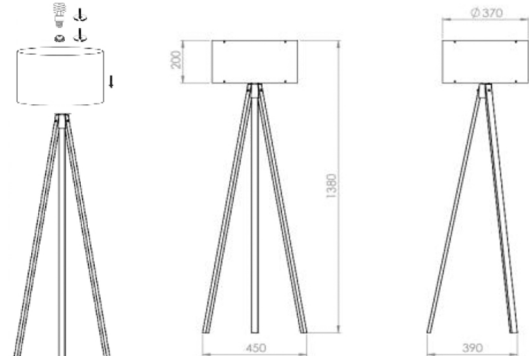

4

Insert the bulb and fix the plug to the 220 V socket inlet and prepare it for use. To illuminate, turn the switch on the cable to the "ON" position.

