

# ASSEMBLY INSTRUCTION

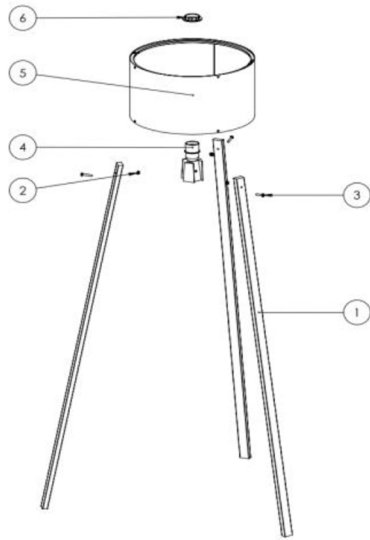

**Packaging content:**

- |   |          |
|---|----------|
| 1 Wooden foot                           | 3 Pieces |
| 2 Nut                                   | 3 Pieces |
| 3 Bolt (star head)                      | 3 Pieces |
| 4 Lampholder and Body (assembled)       | 1 Piece  |
| 5 Lampshade head (De-mounted)           |          |
| 5-1 Subframe (Disassembled)             | 2 Pieces |
| 5-2 Upper frame (Disassembled)          | 2 Pieces |
| 5-3 Lampshade head cover (De-assembled) | 1 Piece  |
| 6 Socket nut                            | 1 Piece  |

1

**Assembly Instruction;**

- 1) Please confirm with the quantity and content information of the parts coming out of the product packaging.
- 2) Assemble the "1" parts one by one with the "3" connection bolt so that the 2 parts remain inside the part numbered "4".
- 3) Assemble the part no. "5" in 3 different assembly sequences as in "Figure A / B / C".

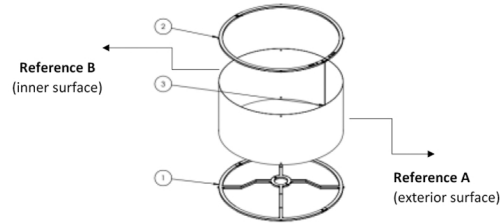

With the "Reference A" surface of part "5-3" facing outward, the following Combine as in the pictures.

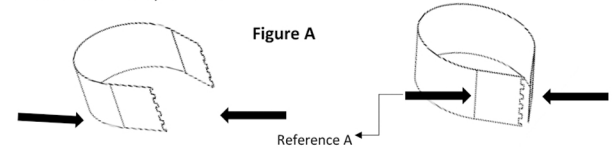

After bringing the piece "5-3" to the stage in "figure A", the ring made from the inside locked by the locking mechanism.

**Figure B**

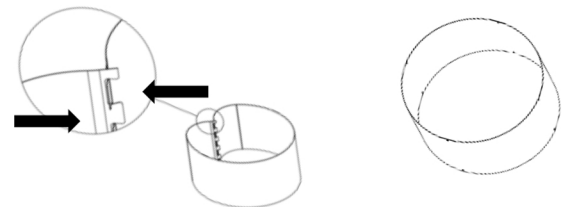

2

The part "5-2" is locked from the double-sided locking mechanism as in "Figure C".

**Figure C**

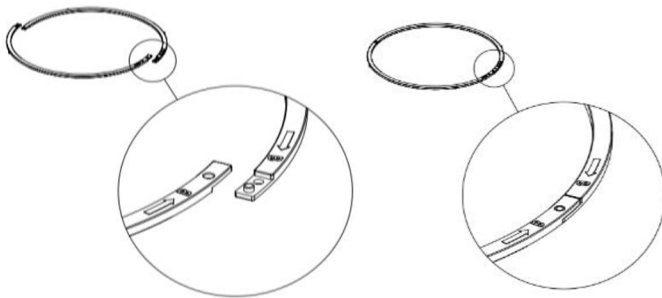

The part "5-3" is locked from the double-sided locking mechanism as in "Figure D".

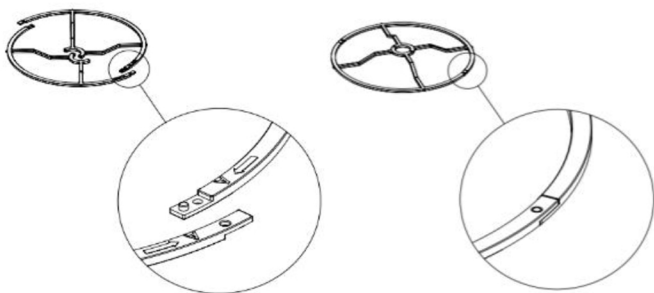

3

The assembled "5-2" and "5-1" parts are mounted through the "5-3" holes.

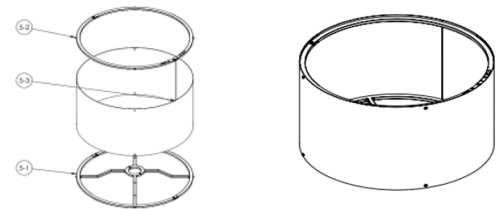

After the "5" part is mounted to the "4" part, the "6" part is "4". It is mounted by screwing to the part.

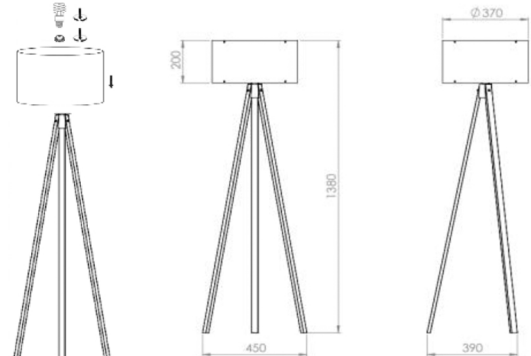

Insert the bulb and fix the plug to the 220 V socket inlet and prepare it for use. To illuminate, turn the switch on the cable to the "ON" position.

4

